

# Design and Construction of the Kishwaukee River Bridges



**R. Shankar Nair**  
Vice President and Chief  
Structural Engineer  
Alfred Benesch & Company  
Chicago, Illinois



**James K. Iverson**  
Consultant  
Wiss, Janney, Elstner & Associates  
Northbrook, Illinois  
(Formerly, Project Manager  
with J. W. Peters & Sons  
segment fabricators for  
the Kishwaukee Bridges.)

**T**he Kishwaukee River Bridges are twin prestressed concrete box girder structures, located in Winnebago County, Illinois. The bridges are part of the Supplemental Federal Aid Freeway, FA412, which is being built to Interstate standards and financed jointly by the Federal Highway Administration and the State of Illinois. This Supplemental Freeway will become the main North-South highway serving the mid-section of Illinois. The site of the Kishwaukee River Bridges is about 4 miles (6½ km) south of Rockford.

The box girders were constructed from precast segments which were erected by means of a launching truss.

This project represented the first use of a launching truss for segmental bridge erection in the United States. Another significant feature of the project is that contractors were given an unusually high (for 1976) degree of freedom to choose their own construction methods and details.

Each of the two bridges supports two lanes of traffic and has a total length of approximately 1170 ft (357 m). The box girders are five-span continuous structures with three interior spans of 250 ft (76.2 m) and end spans of 170 ft (51.8 m). The bridges cross a deep, wooded river gorge. The roadway surface is more than 120 ft (36.6 m) above the river.

Presents the selection of bridge type, design approach and criteria, bidding procedures, design details, fabrication of segments, and erection of superstructure of the Kishwaukee River Bridges in Winnebago County, Illinois. During construction, cracking and other problems occurred in some of the segment joints. The cause of these problems is examined and a method of repair is described which was completed successfully.

## SELECTION OF TYPE OF BRIDGE

The bridges are in an environmentally sensitive area. Early in the development of the project, the State of Illinois decided on various restrictions to be imposed on construction operations to protect the river and the adjacent landscape. For example, removal of hardwood trees larger than 6 in. (152 mm) in diameter was to be permitted only in certain specified areas around each pier. In other areas, only smaller trees could be removed and even those would have to be replaced by the contractor under certain conditions. These and other environmental protection requirements limited the construction procedures and bridge types that could be considered for this site.

Comparative designs and cost estimates were prepared for several different steel and concrete structural systems, subject to the environmental restrictions. The bridge types studied included an orthotropic deck steel girder structure, a concrete deck on steel stringers, a steel arch structure, and a post-tensioned segmental concrete box girder.

The evaluation of alternative bridge types indicated that the post-tensioned

segmental concrete bridge was at least as economical as any other type of bridge, in absolute terms, and offered clearly the best combination of economy, aesthetic value, and compatibility with environmental requirements. Further analysis showed a constant-depth design to be more appropriate — for this location and the anticipated spans — than a variable-depth design with haunches at the piers.

For environmental and economic reasons, it was considered desirable that all piers be out of the water at normal river level. The roadway is not perpendicular to the river. The skewed crossing, together with the requirement that the piers be out of the water, required either lengthening of the span or skewing of the piers with respect to the superstructure (which is not appropriate for the type of structure selected) or the use of twin bridges with staggered piers. Twin bridges were judged to be clearly the best of these alternatives.

On the basis of the preliminary studies and the analysis and evaluation of alternative bridge types, it was decided that the Kishwaukee River crossing for FA412 should be a pair of post-tensioned segmental concrete box girder bridges. A five-span configuration was selected for each structure,

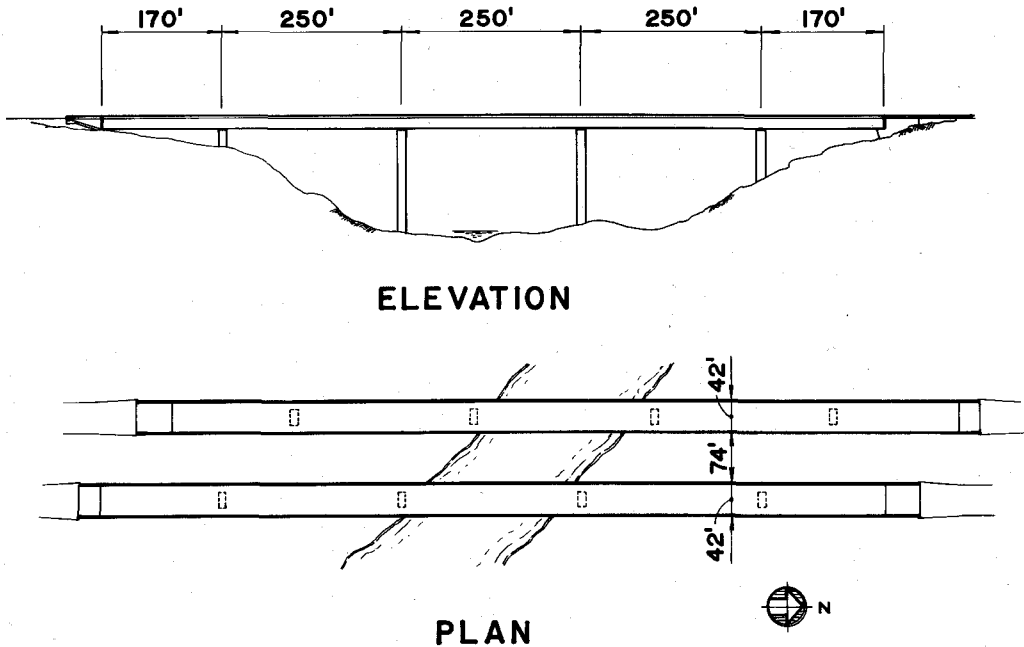

Fig. 1. General layout of Kishwaukee River Bridges.

with interior spans of 250 ft (76.2 m) and outer spans of 170 ft (51.8 m). Each bridge was required to support two 12-ft (3.66 m) traffic lanes; shoulders, curbs, and parapets brought the overall width of each structure to 42 ft (12.8 m). The configuration of the bridges is shown in Fig. 1.

## DESIGN APPROACH AND CRITERIA

The Illinois Department of Transportation (IDOT) and its consultants were well aware that many alternative methods of casting, erection, and post-tensioning were available for the type of structure selected for this crossing. It was decided that contractors should be given the greatest possible degree of freedom to choose from among the available methods and also to innovate and develop new techniques. This approach was expected to result in the most efficient utilization of avail-

able resources of material, equipment and expertise and, consequently, to provide the State of Illinois with the most economical structure.

The major areas in which contractors were to be given the freedom to select their own methods and techniques were (1) method of casting segments, which could be either precast or cast in place, (2) post-tensioning system and details, and (3) method of erection. It was recognized that the contractor's choices in these areas would have a significant effect on the design of the bridge. Nonetheless, it was decided that IDOT should provide bidders with a complete design and a complete set of plans.

The set of plans provided to bidders by IDOT was based on the assumption that the box girder segments would be precast, post-tensioning would be by draped strand tendons with details similar to those of the Freyssinet system, and erection would be accom-

plished by the balanced-cantilever method using a launching truss. These and other assumptions (including details such as the assumed weight and manner of use of the launching truss) were clearly described in the plans and outlined in the specifications. The specifications then gave the contractor the option of using different erection and post-tensioning methods and cast-in-place instead of precast construction.

With respect to erection and post-tensioning, the specifications stated that "Alternate methods of erection and alternate post-tensioning systems may be acceptable. If the Contractor chooses an alternate method of erection, he shall submit all necessary computations, drawings and specifications for approval by the Engineer prior to any work on the project. . . . Calculations shall also be submitted to substantiate the system and method of stressing proposed by the Contractor."

It may be noted that contractors were not required to provide calculations or other information on proposed alternate erection or post-tensioning methods at the time of bidding; this information was required only during the shop drawing phase of the project.

On alternates to precast construction, the specifications stated that "Bids will be accepted on cast-in-place post-tensioned segmental box girder construction. If the option of cast-in-place construction is exercised, the contractor shall specify that his bid is based on the cast-in-place option and, with his bid proposal, shall submit a set of preliminary plans and computations prepared by a Structural Engineer registered in Illinois relative to his design and method of erection of sufficient detail to allow the State to evaluate his proposal for structural adequacy. . . . The aforementioned submittals will be evaluated by the State only if the bid for cast-in-place construction is the lowest bid received. This evaluation

will be done prior to notification of award. . . . If the Contractor is awarded the contract based upon the cast-in-place option, he shall submit a complete set of design plans and computations . . . for review and approval by the State."

The basic design criteria for the "original" design (which is the design represented by the plans supplied to bidders by IDOT) included the following:

1. Design to be in conformance with the 1973 AASHTO Standard Specifications for Highway Bridges.
2. There are to be no tensile stresses in the concrete due to longitudinal flexure of the box girder or transverse flexure of the top slab at any time during construction or under design loadings on the completed bridge.
3. Design live loading to be HS-20.
4. Design dead load to include possible future wearing surface weighing 25 psf (1.20 kPa).
5. Design to include the effect of the temperature of the top slab being 18 deg F (10 deg C) higher or 9 deg F (5 deg C) lower than the temperature of the remainder of the box section.

These basic design criteria were also applicable to alternate designs proposed by contractors. The specifications also required that the alternates comply with the following restrictions:

1. The exterior dimensions of the box section could not be altered.
2. The location and general shape of piers and abutments could not be altered.
3. All environmental requirements in the specifications were fully applicable to the alternate designs. (Note that these requirements effectively eliminated the possibility of building the superstructure on falsework off the floor of the gorge.)

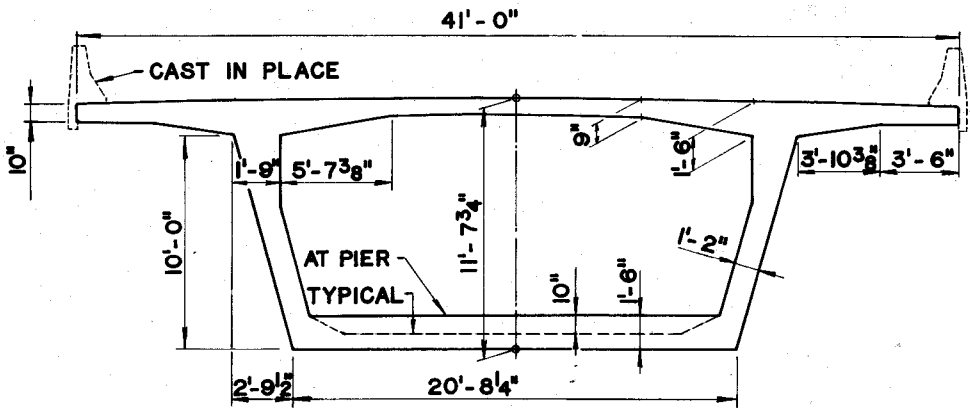

Fig. 2. Girder cross section.

## BIDDING AND CONTRACT AWARD

The Kishwaukee River Bridges were expected to be the first precast segmental bridge structures constructed in Illinois and the first segmental bridges anywhere in the United States to be erected with a launching truss. IDOT felt that because of the new design and erection concepts involved in this project, a pre-bid orientation conference would be useful. At the pre-bid conference, engineers from IDOT and the consulting firms made presentations to describe segmental bridges in general and the Kishwaukee project in particular, with the main objective of making potential bidders aware of the complexities of the type of construction anticipated for these bridges. The conference was attended by about 100 people representing general contractors, precasters, post-tensioning contractors and consultants.

Seven general contract bids were received. Two of the bids were based on cast-in-place construction of the superstructure and were submitted with packages of design information as required by the specifications. Since neither of these bids was the low bid, the design packages were returned

without review or evaluation. The low bid of about \$5.3 million was received from Edward Kraemer & Sons, Inc. of Plain, Wisconsin, and was based on the use of precast segments. This bid amounted to about \$53 per sq ft (\$570/m<sup>2</sup>) of deck and was well below IDOT's estimate. The second lowest bid was less than 3 percent higher than the low bid. The contract was awarded to Kraemer in November 1976.

Edward Kraemer & Sons, Inc. put together a team that included J. W. Peters & Sons as precasters to fabricate box-girder segments, Heavy Construction Services as erectors of the superstructure and Dywidag Systems International USA, Inc. as post-tensioners and designers of alterations to the original superstructure design. Foundation, pier and abutment construction, sitework, and supplemental deck work was done by Kraemer's own forces.

The contractors decided on certain changes to the original superstructure design, as permitted by the specifications. The most significant change was the use of straight threaded bars instead of draped tendons for longitudinal post-tensioning. Other changes included an increase in the size of segments and minor changes in erection procedure. These alterations required

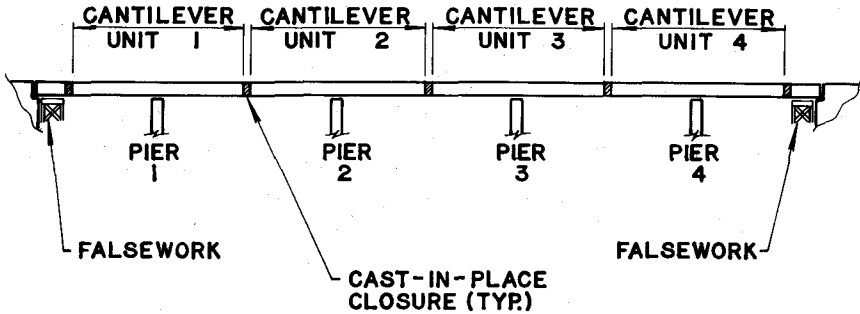

Fig. 3. Division of bridge into balanced cantilevers.

complete re-analysis and redesign of the bridge superstructure. As called for in the specifications, calculations and design drawings were developed by the contractor and submitted to IDOT for review by IDOT's consultants.

In the following discussion of the design of the Kishwaukee bridges, the design represented by the plans supplied to bidders by IDOT (which was developed by IDOT's consultants) will be referred to as the "original" design. The design that resulted from the changes made by the contractor will be identified as the "contractor's redesign" or by other appropriate means.

## DETAILS OF DESIGN

The basic bridge configuration is shown in Fig. 1. The superstructure is a five-span continuous post-tensioned concrete box girder made up of precast segments. The three inner spans are 250 ft (76.2 m) long; the outer spans measure 170 ft (51.8 m). The bearings at the two innermost piers are fixed against longitudinal movement; expansion bearings are used at the other piers and the abutments. All bearings are "pot" bearings that allow free rotation of the superstructure relative to the substructure components.

Each of the piers is a single non-prestressed reinforced concrete column. The tallest pier measures approximately 110 ft (33.5 m) from bearing seat to the ground surface and is about 25 ft (7.62 m) wide by 10 ft (3.05 m) thick at the base. All pier and abutment foundations are either footings on rock or piles bearing on rock. The rock occurs close to the ground surface over most of the site and is exposed in some areas. Piers were designed for all the normal AASHTO loadings plus an earthquake-induced horizontal load of 6 percent of structure weight. The design strength of the concrete in the piers is 3500 psi (24.1 MPa).

The cross section of the superstructure is shown in Fig. 2. The box girder section is essentially constant throughout the five-span structure except for an increase in the thickness of the bottom slab [from 8 to 18 in. (203 to 457 mm)] near each pier. The width of the girder is 41 ft (12.5 m) and the overall depth is about 11 ft 8 in. (3.56 m) (excluding the cast-in-place parapets). The webs are 14 in. (356 mm) thick. The thickness of the top slab is 10 in. (254 mm) at the ends of the wings, 9 in. (229 mm) at the middle of the box, and 18 in. (457 mm) at the webs. The top slab is post-tensioned in the transverse direction by

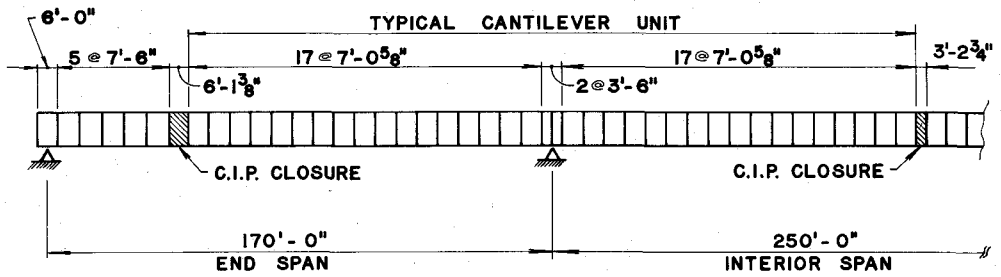

Fig. 4. Division of bridge into segments.

means of high-strength bars. These cross-sectional dimensions are as actually used in the bridge, following the contractor's redesign. The dimensions in the original design were not significantly different. The design strength of the concrete in the precast box girder segments is 5500 psi (37.9 MPa).

The division of the bridge superstructure into balanced cantilevers is indicated in Fig. 3. The superstructure design is based on construction of a pair of balanced cantilevers at each of the four piers. The system of cantilevers is complemented by a short length of bridge erected on falsework adjacent to each abutment. The cantilevers and the structure erected on falsework are constructed out of precast segments. The girders are completed by short sections cast in place between the portions of bridge assembled from precast segments.

Segment lengths are indicated in Fig. 4. The dimensions shown reflect the increase in segment size that was part of the contractor's redesign. In the original design, segment weight was limited to 40 tons to facilitate highway transportation; maximum segment length was 5 ft 6 in. (1.68 m). The contractor's redesign reduced the number of segments by about 20 percent. The heaviest segments weigh about 50 tons.

At each interface between segments, there is a large key in each web and smaller alignment keys in the top and

bottom slab. The dimensions of the web key are shown in Fig. 5. These dimensions were not altered in the contractor's redesign.

The web keys were not designed to function as the primary shear-transfer device between segments. Epoxy is used in all joints. The keys are only intended to support the weight of one or a few segments before the epoxy has cured. After proper curing of the epoxy, the jointed girder was expected to support shear in a manner similar to a monolithic structure, with the epoxy sustaining a combination of shear and normal stress over the entire height of the joint.

The girder webs were designed accordingly. Mild steel (Grade 60) shear reinforcement was provided as required. In the original design, which included draped tendons for flexure, a portion of the shear force was supported by the vertical component of the tension in the tendons. The contractor's redesign eliminated the draped tendons and required an increase in shear reinforcement. [The maximum shear reinforcement consists of #7 bars at 10-in. (254 mm) centers on each face of each web.]

The original design for longitudinal flexure was based on the use of post-tensioning tendons located in the webs and in the top and bottom slabs close to the webs. The details of the design were based largely on the details and

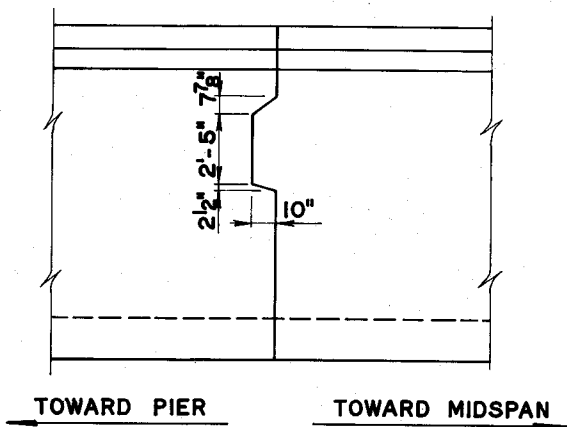

Fig. 5. Typical web key.

dimensions of the Freyssinet system. In the contractor's redesign, longitudinal post-tensioning is achieved entirely by means of Dywidag high-strength [155 ksi (1069 MPa)] threaded bars located in the top and bottom slabs. The use of these threaded bars, which can be used in small increments of length and coupled very conveniently, offered certain advantages during erection. All the Dywidag bars are 1¼ in. (32 mm) in diameter. The number of bars in the top slab varies from one hundred over the piers to two at the cast-in-place closure sections; the number of bottom bars varies from forty at typical midspan closures to two at the piers.

The design of the box girder for longitudinal flexure was determined, to a large degree, by the erection procedure and construction loads. (Construction procedures are described elsewhere in this article.) Both the original design and the contractor's redesign were based on erection using a launching truss. The erection sequence and manner of operation of the launching truss were similar in both designs. The contractor's method of moving the truss from one pier to another was different from that assumed in the original design, but this difference did not affect

the maximum loading on the bridge. The weight of a particular European launching truss was used in the original design computations. The contractor's redesign took advantage of a lighter truss that was designed and built specifically for the Kishwaukee project by the erection subcontractor.

## FABRICATION OF SEGMENTS

### Form

The precaster chose the short line method of precasting and picked the U.S. Division of Stelmo, Limited, a British company, to accomplish both design and manufacture of the segment form. Completion required about 6 months, although a portion of the form was shipped early and used to cast a number of special diaphragmed segments over the piers.

The short form casting method utilized for this project features two adjustable soffits or carriages supporting the match-cast and casting segment. The cantilevers or individual portions of the bridge from each pier to center span are cast segment-by-segment. A fixed bulkhead forms the leading face



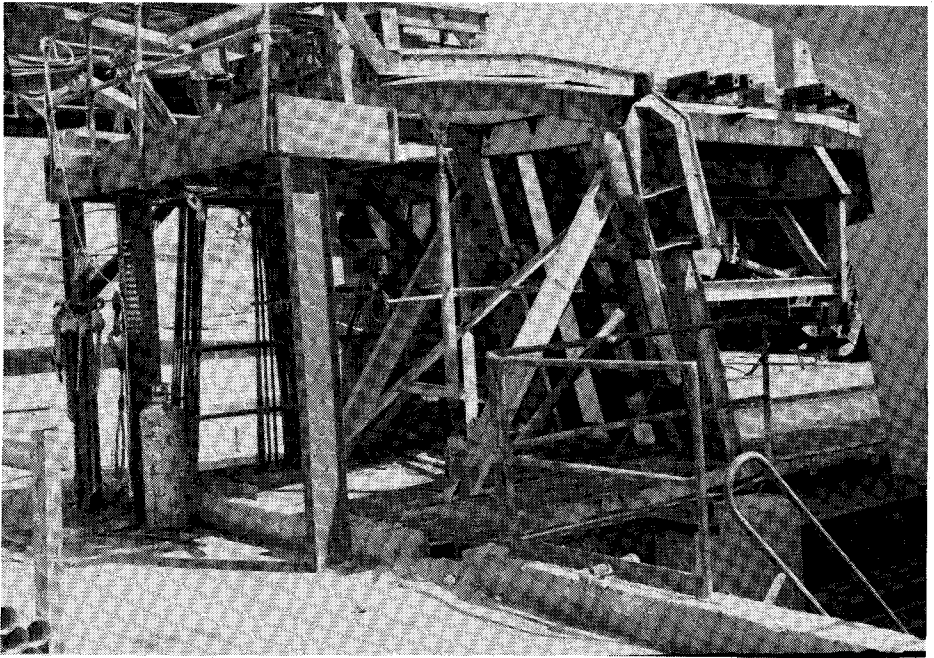

Fig. 6. Form under wings.

of each new segment and the match-cast segment forms the rear face. Side forms that seal at the match-cast segment and the bulkhead form the outside of the segment and support the segment wings. Fig. 6 shows the forms under the wings.

To aid the access to the form and ease lifting equipment requirements, the carriages were placed in a sunken pit, as shown in Fig. 7.

An expanding inner form or mandrel supports the center portion of the top slab and inside vertical faces of the two webs. The mandrel is also movable and cantilevers through the bulkhead from an exterior support frame upon which it can be rolled in or out of the segment for cleaning. This is shown in Fig. 8. The fixed bulkhead can also be seen here with the void boxes for the post-tensioning anchorage pockets already mounted. The threaded bar system led to a number of anchor locations.

The design and detailing of this type

of form follow European developments and have been described in the literature on segmental bridges. However, the precaster must follow the development of each particular design, relate to the details of the post-tensioning and always strive to minimize setup and stripping effort. For example, the Kishwaukee form utilizes tie bolts through the webs. These tie bolts control the local spreading of the form and were found to be required if the segments were to meet specified tolerances. However, they are a problem during setup when they must be threaded through the reinforcing cage and their removal is time-consuming and an easily missed step during stripping. The installation and removal of these items occur on every casting for over 300 segments, and even a minor difficulty can lead to large total project costs.

This form utilizes a mix of hydraulic jacks and large screw jacks to provide

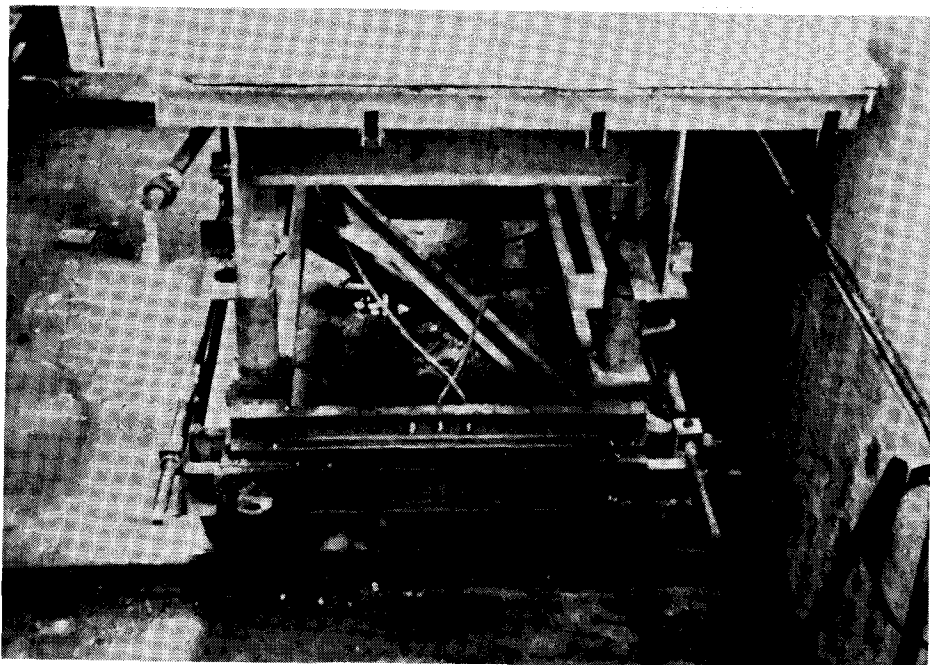

Fig. 7. End view of soffit form on carriage in pit.

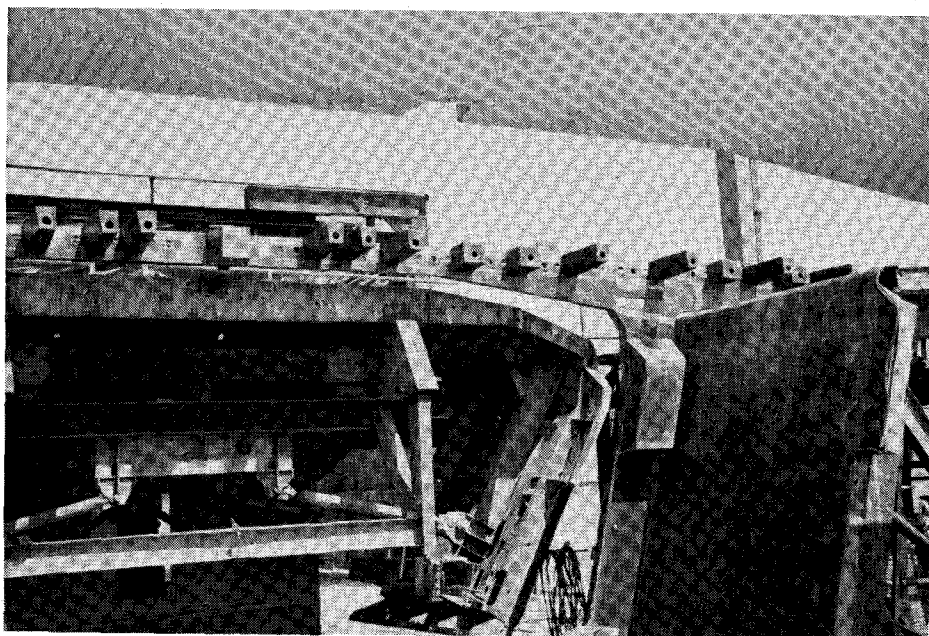

Fig. 8. Fixed bulkhead with post-tensioning void boxes and mandrel extracted. The mandrel cantilevers through the bulkhead from an exterior support frame upon which it can be rolled in or out of the segment for cleaning.

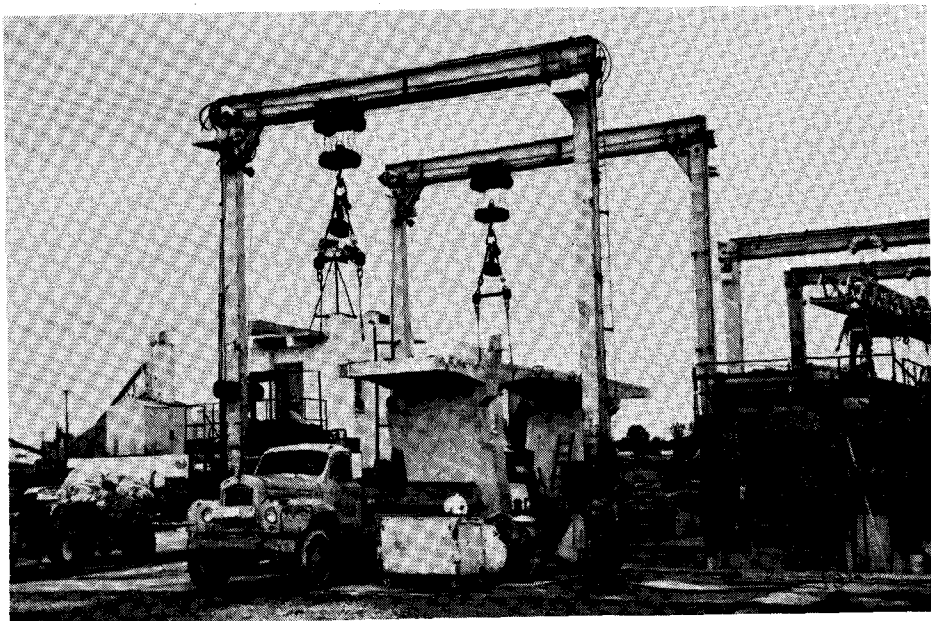

Fig. 9. Modified travel-lift.

form movement and adjustment. The large screw jacks utilized under the wing are visible in Fig. 6. These are primarily used for stripping and sealing movements. A critical spot for form movement is adjustment of the bottom forms or carriages. The carriages must be capable of vertical movement (for elevation control) and horizontal adjustment. Vertical adjustment is made by 6-in. (152 mm) hydraulic jacks with locking collars as can be seen in Fig. 7. The horizontal adjustment is handled by two turn bolts on the front and rear of the carriage and a set of teflon slide plates between two lower "layers" of the carriage. Straightforward adjustment of the form is a necessity if speed and efficiency in production are to be realized. Adjustment tolerances on the match-cast segments were normally set at  $\frac{1}{16}$  in. (1.6 mm).

The bulkhead, shown in Fig. 8, is fixed perpendicular to the longitudinal control line and is not moved or adjusted in normal casting sequences. It

can be moved longitudinally on its bed to permit casting different length segments, but this was done only a few times on the project, and was a time-consuming adjustment.

### Improvements in Casting Yard

The casting on this project was done in an existing J. W. Peters precasting yard in Burlington, Wisconsin. Fortunately, considerable unused land was available, but it did require some re-grading and stabilization for storage areas. This allowed several desirable features in the casting site:

1. Adjacent segment storage, material storage and concrete batching facility.
2. Geometry control transit sighting to north to minimize sun interference.
3. Good soil conditions.
4. Existing electric service and steam lines.
5. Space available for an adjacent rebar cage assembly jig.

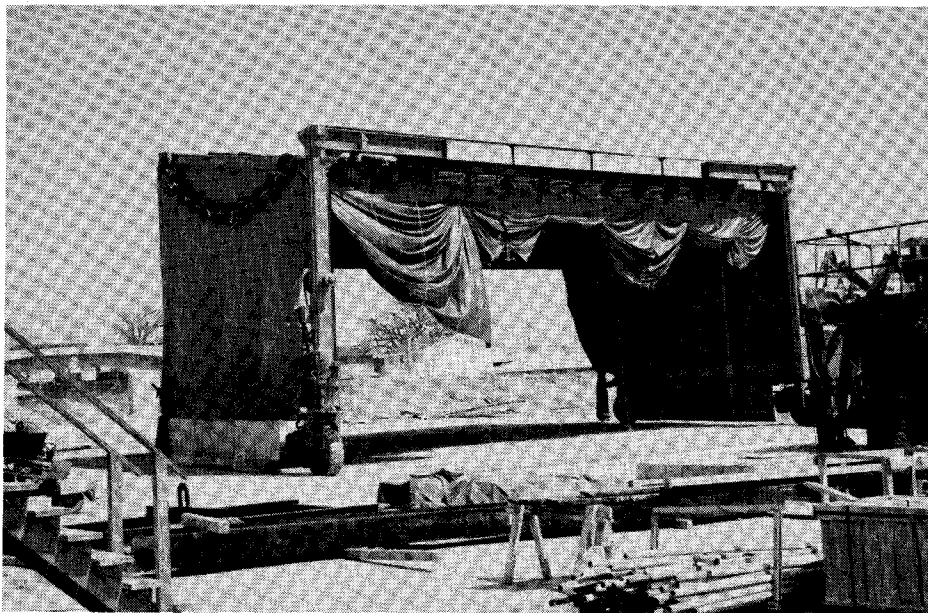

Fig. 10. Winter form cover.

The handling of the segments was accomplished by modifying an old travel-lift or straddle crane to lift the 50-ton segments. The span of the machine was reduced to obtain the required capacity and the lifting system was totally rebuilt. Retractable jacks were added at the wheels to increase the static lifting capacity. The machine is shown in Fig. 9. A similar standard large span machine was used for lighter segments, cage-handling and other lifting.

The scheduling of this project required casting through the Wisconsin winter. Another older travel-lift was modified to span the entire casting operation and a canvas hood was placed over this machine. This provided a rolling cover for the form. This machine is shown in Fig. 10. Even with this protection and additional heat, continuing one-a-day production was never realized in the coldest winter months.

To allow one day turnaround, conventional high-early-strength cement

and steam heat were used and were generally satisfactory. Slumps over 3 in. (76 mm) were required in casting the lower portions of the segment. External vibrators were used, but could only be used for short intervals during critical portions of the casting or seal difficulties appeared. Hand-held internal vibrators were utilized throughout the casting.

The existing 4 cu yd (3.06 m<sup>3</sup>) turbine mixer which was used for all plant concrete was used to mix the concrete for the segments. The use of superplasticizers was considered but was initially discarded based on high cost and concern about reliability under widely varying temperatures. However, later in the job this additive was used with good success. The specified concrete strength of 5500 psi (37.9 MPa) was obtained reliably except in the coldest winter months.

This type of construction demands very close geometry control to assure that the completed bridge alignment is

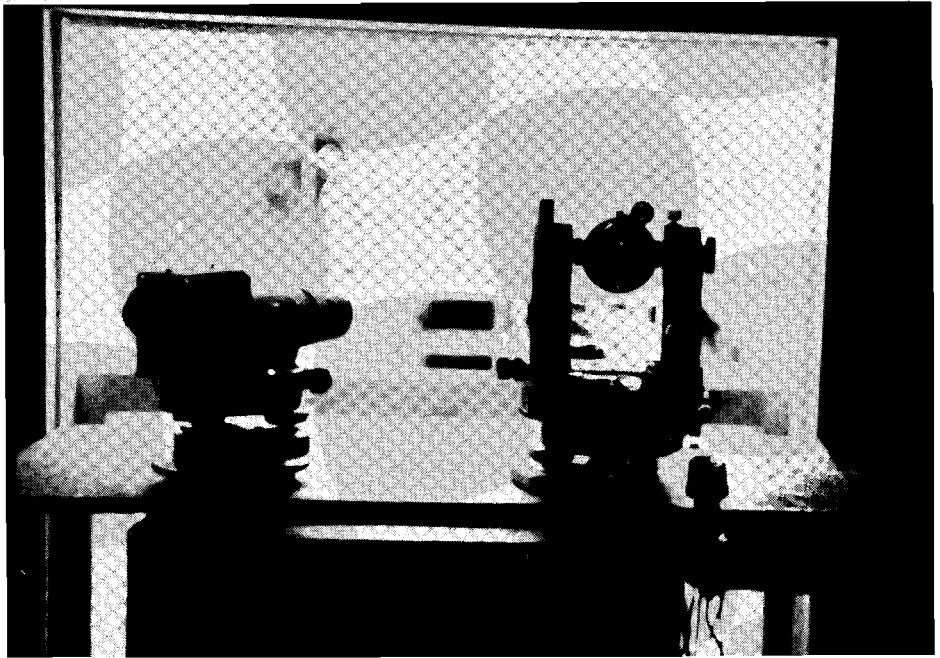

Fig. 11. Measuring equipment.

accurate. A building was erected to house the surveying equipment, which must be elevated to read control points set in the top of the segment. The "transit house" was a two-story building housing the measuring equipment on the upper level and providing an office for the IDOT representatives on the lower floor. The instruments were mounted on the top of an independent column sheltered inside the building but isolated from it to prevent temperature movement, as shown in Fig. 11.

The casting yard features a small but complete steel shop and it was elected to bend the reinforcing bar in-house. This provided considerable flexibility in correcting or obtaining special requirements, and this was found to be essential. A special jig was assembled to form a complete cage in an area adjacent to the form and this is shown in Fig. 12. Cages were assembled by a small crew a day ahead of their use in

the form. This required considerable coordination and crew flexibility which could be accomplished with the close proximity of the two operations.

Earlier experience demonstrated that the casting of the special short segments with internal diaphragms at the piers or abutments was a difficult and time-consuming casting problem. The length of the segments at the piers was  $3\frac{1}{2}$  ft (1.07 m) and since they occurred in pairs, match-casting a set was necessary. Initial casting was done in the primary form previously described, but the interruption of the regular production was causing considerable delay. A separate simpler form was assembled and a separate operation was begun to cast the remaining diaphragmed segments. This is shown in Fig. 13.

Six geometry control points were set on the top surface of each segment; two on the longitudinal bridge centerline near the joints, for horizontal control,

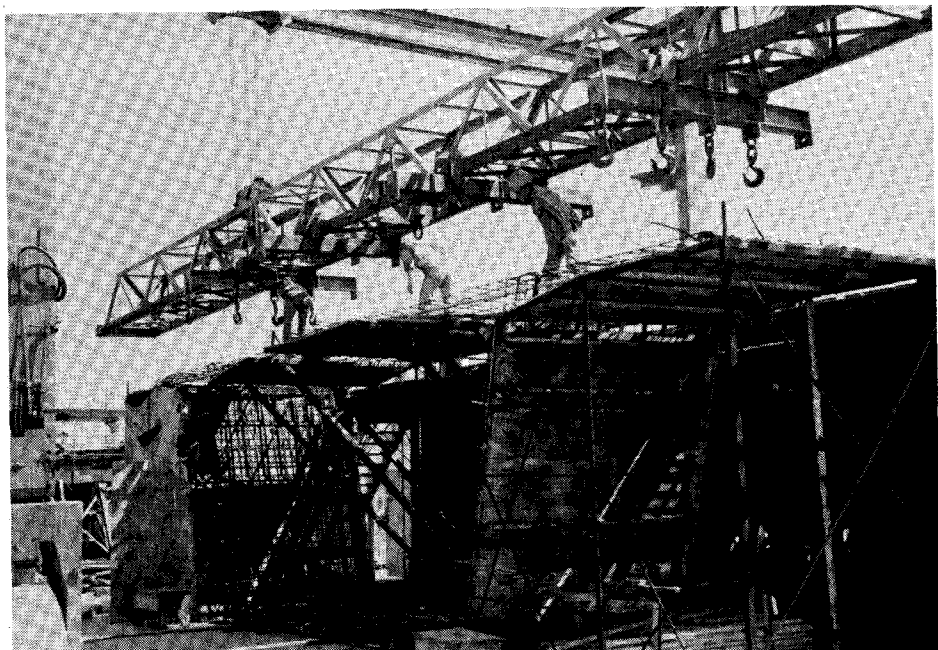

Fig. 12. Reinforcing cage in jig.

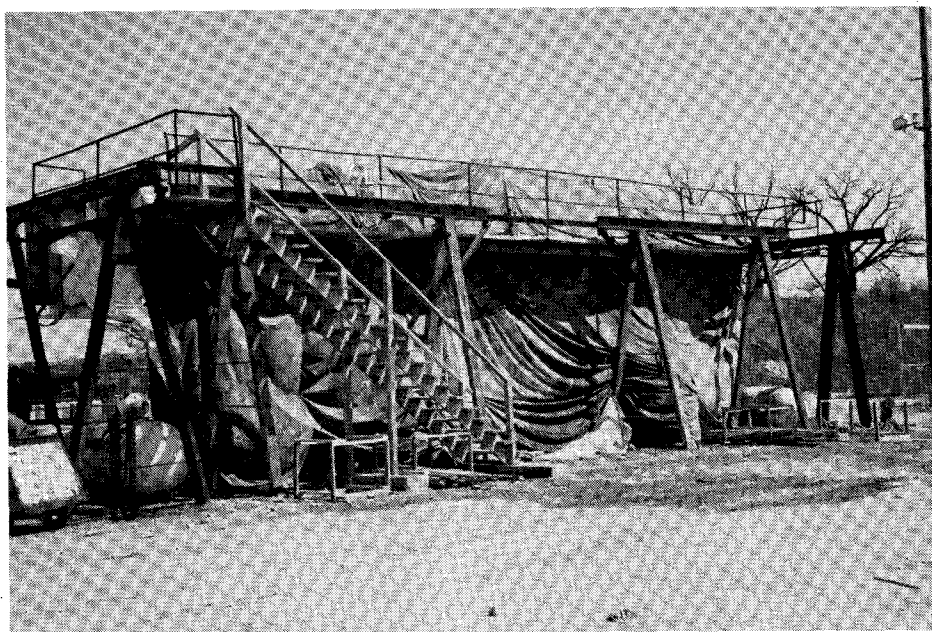

Fig. 13. A separate form for diaphragmed segments, shown here with insulating tarps, was assembled to speed casting operations.

and four at 10 ft (3.05 m) on each side of this centerline, near the joints, for elevation control. The bridges at Kishwaukee are straight horizontally, but each has a partial curve and also straight tangent in the vertical direction.

### **Geometry Control**

The general procedure for geometry control consists of making the necessary computations, adjustment of the match-cast segment for casting, and finally taking record readings between the two hardened segments while they are still locked in the forms before stripping.

The computations can be accomplished graphically or utilizing forms developed for the purpose. They are accomplished in two steps. First, the record readings taken in the casting bed are utilized to calculate where the newly-cast segment will lie in the completed bridge. Then the attitude of the newly-cast segment as a match-cast element is computed.

A self-leveling level and surveyor's transit were used to make measurements. The readings were taken to  $\frac{1}{64}$  in. (0.4 mm) to assure that  $\frac{1}{32}$ -in. (0.8 mm) accuracy was attained. This high degree of precision is necessary on segments near the piers since any error will be magnified up to 20 times near the end of the cantilever. The setup of the segments over the piers in the match-cast position is particularly sensitive and had to be very accurately measured and carefully checked. A system of cross-slope checks was utilized to monitor elevation accuracy and a secondary triangular measurement was made at the pier segments to check horizontal accuracy.

### **Shop Drawings and Production Drawings**

A set of shop drawings showing seg-

ment locations and designations, details of concrete post-tensioning and reinforcing steel, overall location of post-tensioning pockets and casting profile curves was prepared.

A production drawing was made for each segment. This drawing was used at the casting bed and reinforcing cage jig and shows the details appropriate to the segment being produced.

A number of submittals to IDOT was required. All production and shop drawings had to be submitted for approval in several copies. Well over 5000 sheets of drawings were submitted.

### **Transverse Post-Tensioning**

The Kishwaukee project features the use of high-strength Dywidag bars for all post-tensioning. The bridge utilized transverse post-tensioning and this was installed prior to casting and was stressed in the yard. A typical installation is shown in Fig. 14.

### **Hauling of Segments**

The 11 ft 8 in. (3.56 m) high, 50-ton segment required special low-boy trailers. These were obtained from a prior project of this type. The haul of over 50 miles (80 km) through Wisconsin and Illinois led to a number of permits and the requirement for escorts on the turnpike. Standard hauling trucks were used, but special care was required at the project site to ensure that all haul roads were well graded and maintained.

## **ERECTION OF BRIDGES**

The box girder segments were erected using a launching truss. The manner of use of the launching truss and the procedure for moving the truss along the bridge are shown schematically in Fig. 15. The sequence of operations is as follows:

1. A few segments adjacent to the



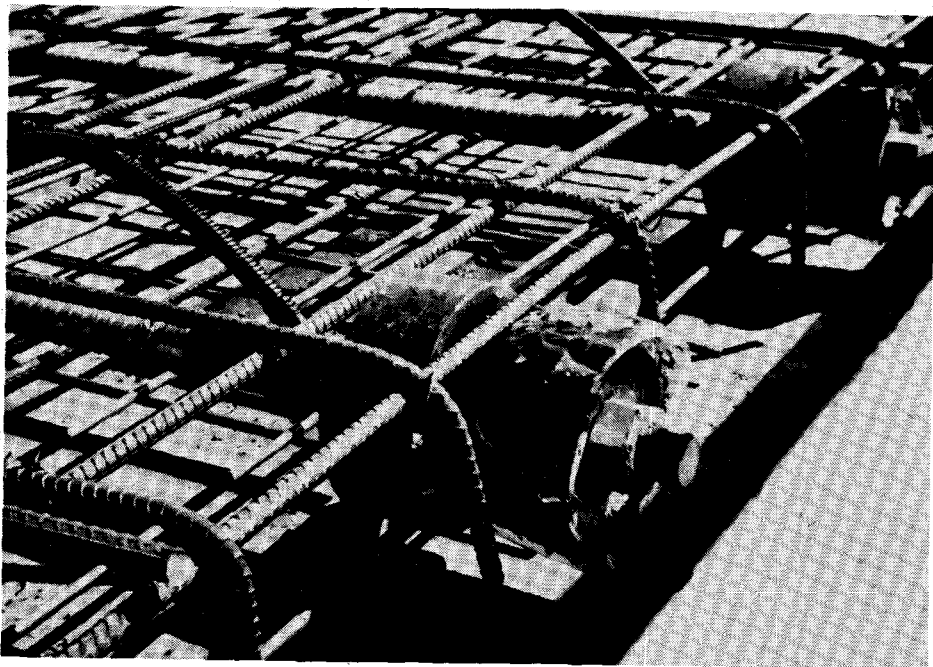

Fig. 14. Transverse post-tensioning anchors in form.

abutment are erected on falsework. Epoxy is used in the joints between segments; longitudinal prestress bars are installed and tensioned as erection proceeds. A steel tower is erected on the first pier. Rollers are installed on the legs of the launching truss and the truss is moved forward until its front end is over the pier tower.

2. With the truss supported on its rear leg and on the pier tower in front, the rollers are removed from the middle leg. The truss is moved forward until the middle leg is over the pier. The rollers on the rear legs are removed. The pier tower is partially removed and replaced with a strut that allows room on the pier top for installation of the pier segments. (The "pier segments" are the two diaphragmed box-girder segments located directly above each pier.) The launching truss is now used to erect the pier segments, which are installed on temporary bearings and

rigidly tied down to the pier by means of temporary vertical post-tensioning. The middle leg of the launching truss is lowered onto the pier segments. The launching truss is now in its working position over the first pier.

3. The segments in the first balanced cantilever unit are erected using the launching truss. Epoxy is used in the joints between segments. Longitudinal prestressing bars are installed and tensioned as erection proceeds.

4. The cast-in-situ "closure" is formed and poured between the end of the cantilever and the short length of bridge previously erected on falsework. Longitudinal post-tensioning is applied across the closure. The temporary vertical "tie-down" post-tensioning at the pier is released and the permanent bearings are installed. The steel pier tower is erected on the second pier. Rollers are installed on the legs of the launching truss and the truss is moved



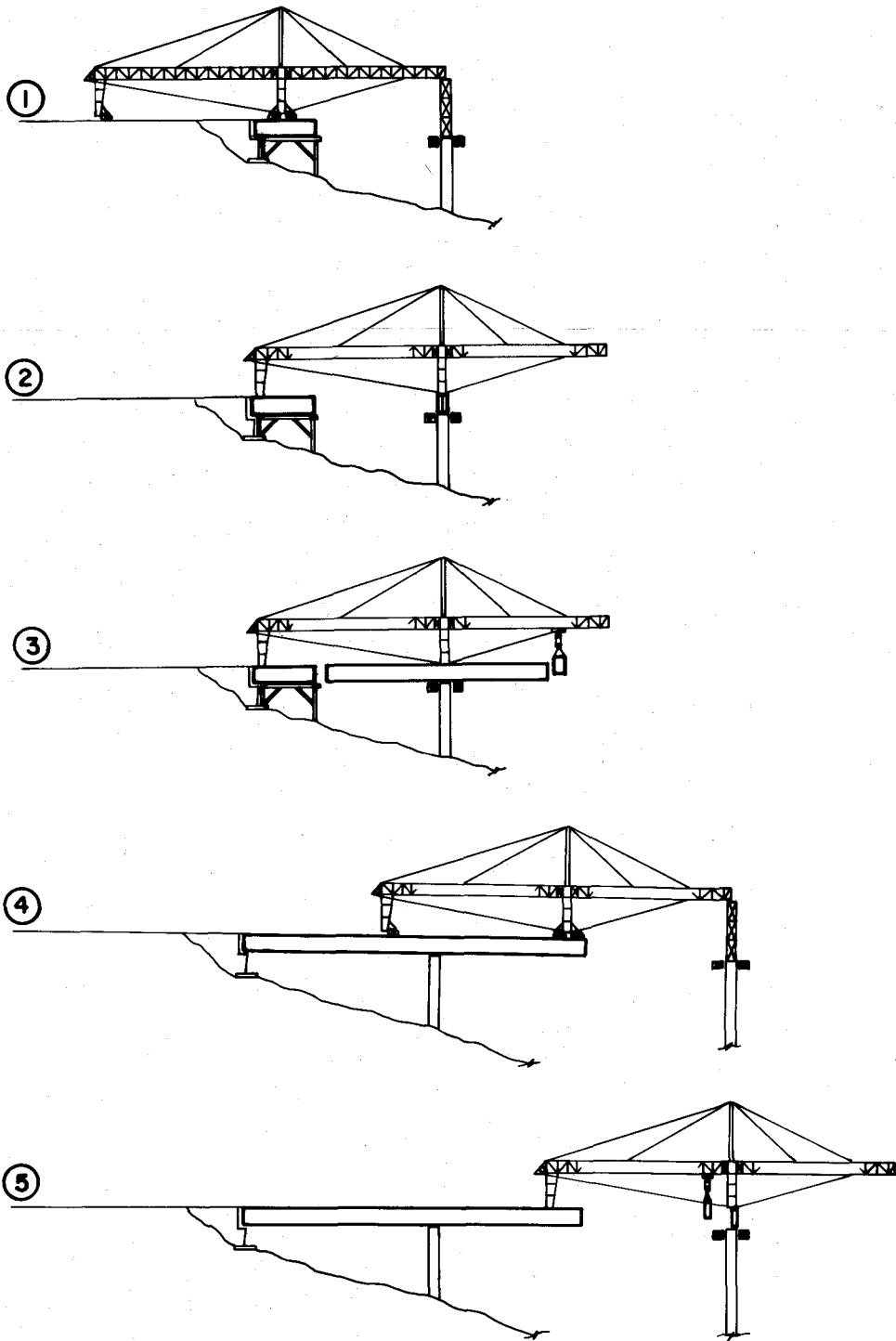

Fig. 15. Sequence of launching truss operations.

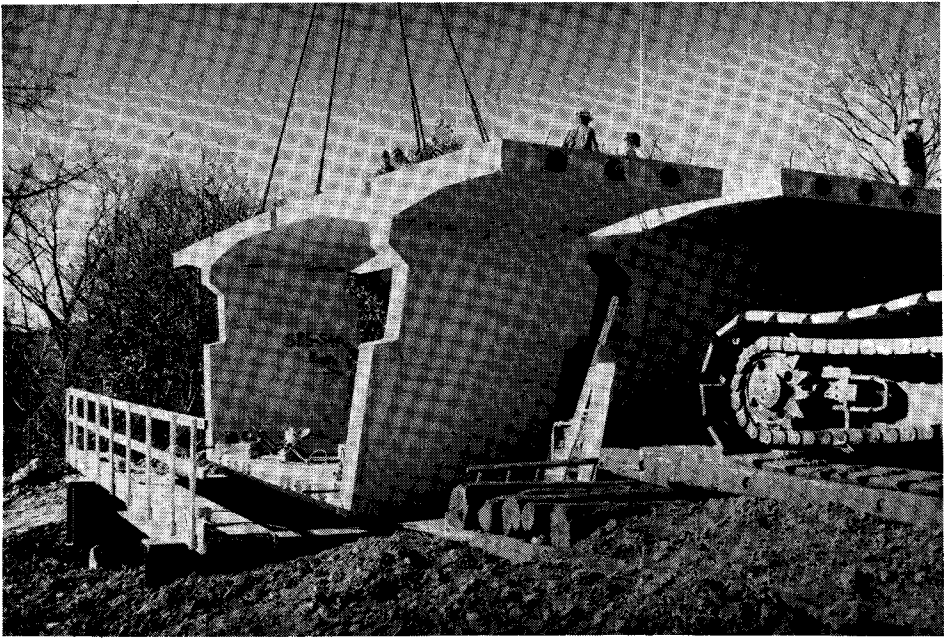

Fig. 16. Segment near abutment being erected on falsework.

forward until its front end is over the pier tower. (The moment on the cantilever will reach its maximum value at this time, before the front end of the launching truss has been picked up by the pier tower.)

5. The launching truss is moved forward and installed in its working position over the second pier, using a procedure similar to Step 2. The second balanced cantilever unit is then erected and the midspan closure between the first and second units is formed and poured. The launching truss will then be ready to be moved to the next pier. This sequence of operations continues until the entire superstructure has been erected.

The erection of the cantilever segments for the west bridge (for the southbound traffic lanes) began in the summer of 1978. By this time, a considerable stockpile of segments had been built up in the precaster's yard; the fab-

rication of segments had begun about a year earlier. All four balanced cantilevers for the west bridge were completed by November 1978 and the entire box girder from abutment to abutment was in place by late April 1979. The erection procedure closely followed the sequence of operations listed above and illustrated in Fig. 15. Various stages of erection are shown in Figs. 16 through 20.

The superstructure of the second bridge was erected in 1980. Though both bridges were now structurally complete, they were not opened to public use until August 1982. In the interim, they were used to transport more than 1,000,000 cu yds (764,100 m<sup>3</sup>) of earth fill for the highway approaches. The wearing surface on the bridge decks was installed just prior to opening to avoid damage by the earth-hauling equipment. The completed bridges are shown in Fig. 21.

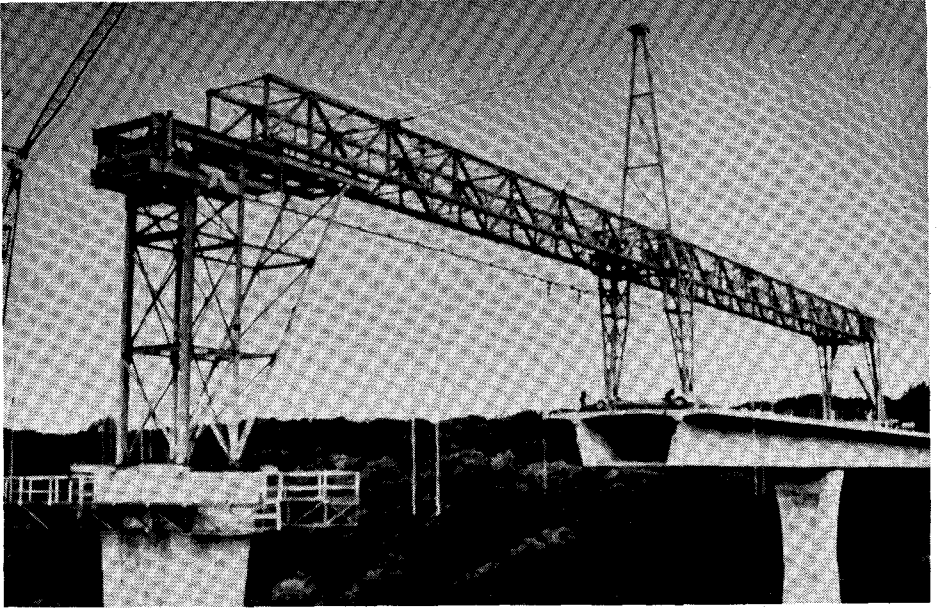

Fig. 17. Launching truss about to be moved to new location. Note temporary steel tower on pier in foreground.

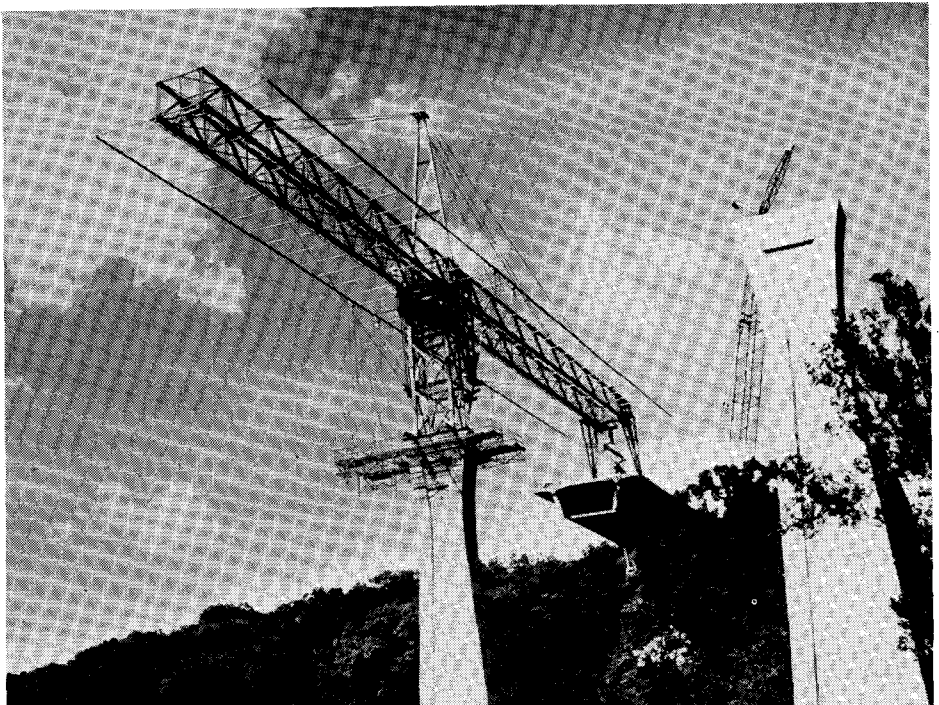

Fig. 18. Launching truss at completion of movement to new location.

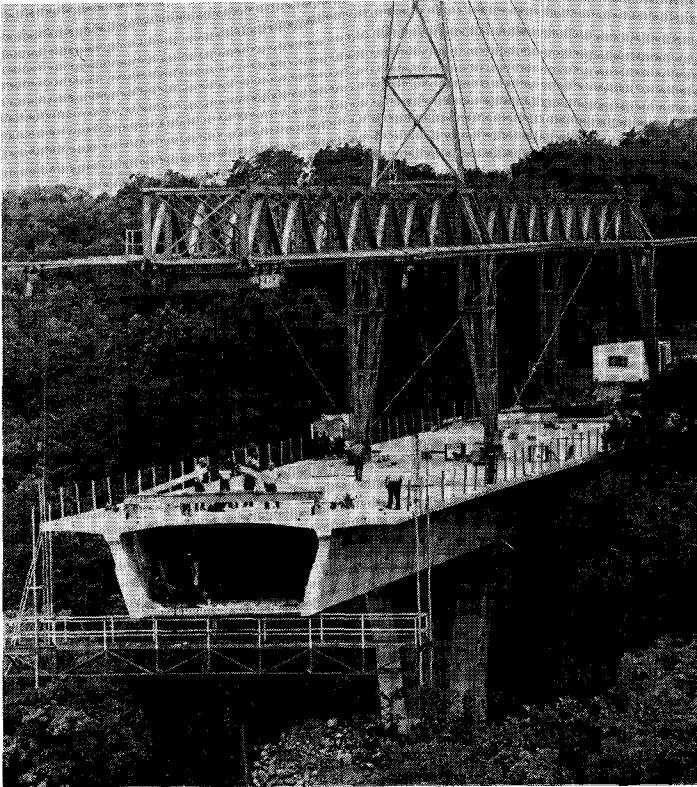

Fig. 19. Cantilever nearing completion.

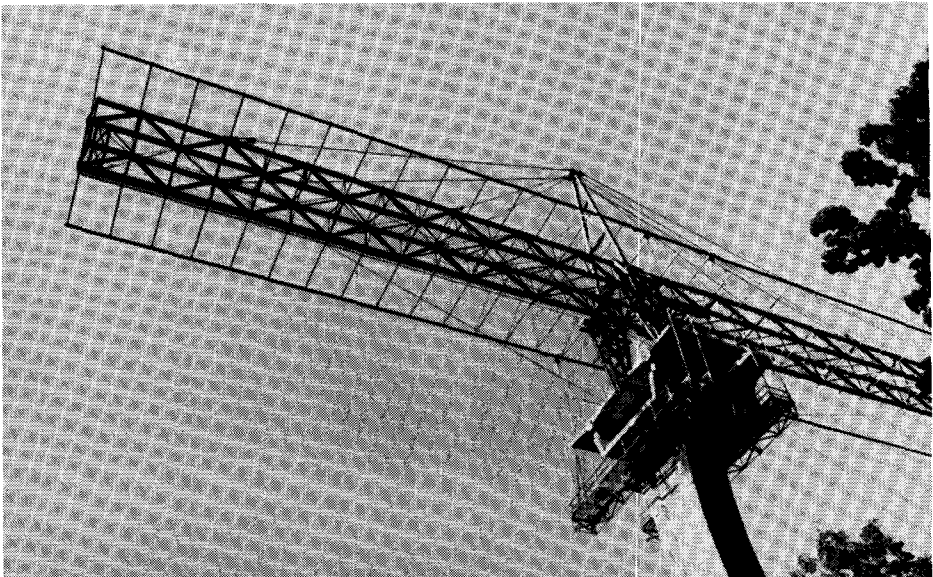

Fig. 20. Early stage of cantilever erection.



Fig. 21. Completed bridges.

## JOINT PROBLEMS AND REPAIRS

On May 10, 1979, cracking and other distress was observed in the west bridge (the first bridge to be built). The bridge structure was essentially complete at that time, except for parapets and the wearing surface. All the precast segments and cast-in-situ closures were in place and all post-tensioning had been completed. The launching truss had been moved off the bridge a few days earlier. The bridge superstructure was supported on its permanent bearings at all piers; all tie-downs at piers had been removed. Cantilever erection of the second bridge had not yet begun but six segments adjacent to an abutment had been erected on falsework.

There was obvious evidence of distress at and near the joint between a

pier segment and the cantilever segment immediately adjacent to it (see Fig. 22). In the east web of the box girder, the bottom of the male shear key at this joint had crushed and the inner surface of the key had spalled over much of its area. The outer surface of the web of the pier segment had delaminated and spalled over a large area between the key and the bearing. These conditions are shown in Figs. 22, 23, and 24.

There appeared to have been a relative vertical movement or slip of about  $\frac{1}{2}$  in. (13 mm) in the east web at the distressed joint. The magnitude of this slippage could be inferred from the gap that appeared at the top of the key (see Fig. 24). There was no evidence of any relative vertical displacement at the joint in the west web.

The upper surface of the top slab did

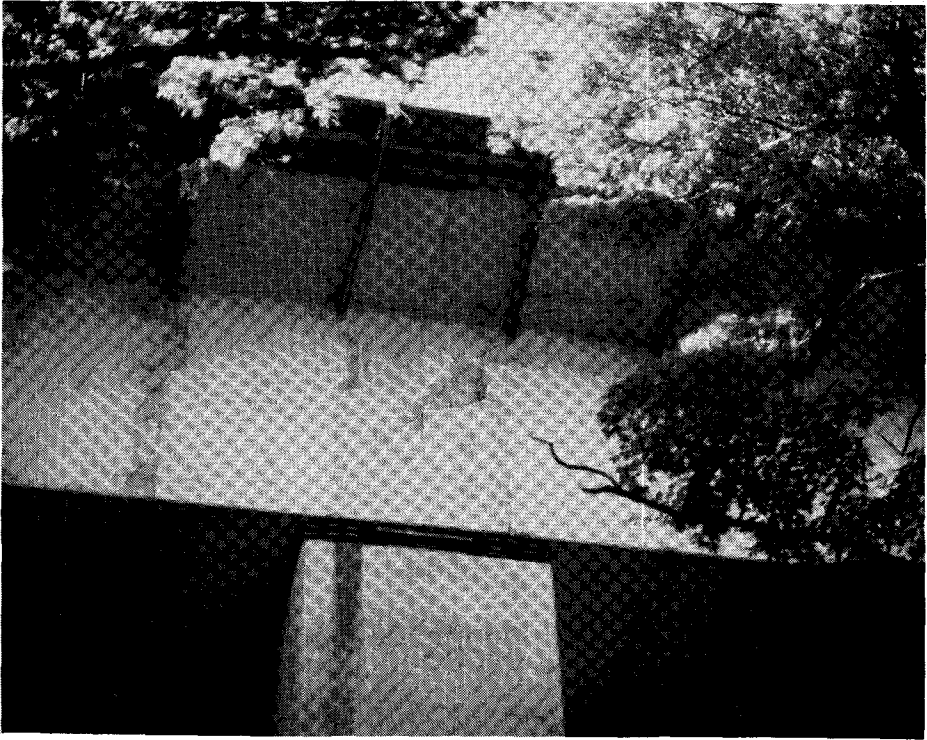

Fig. 22. Damaged girder.

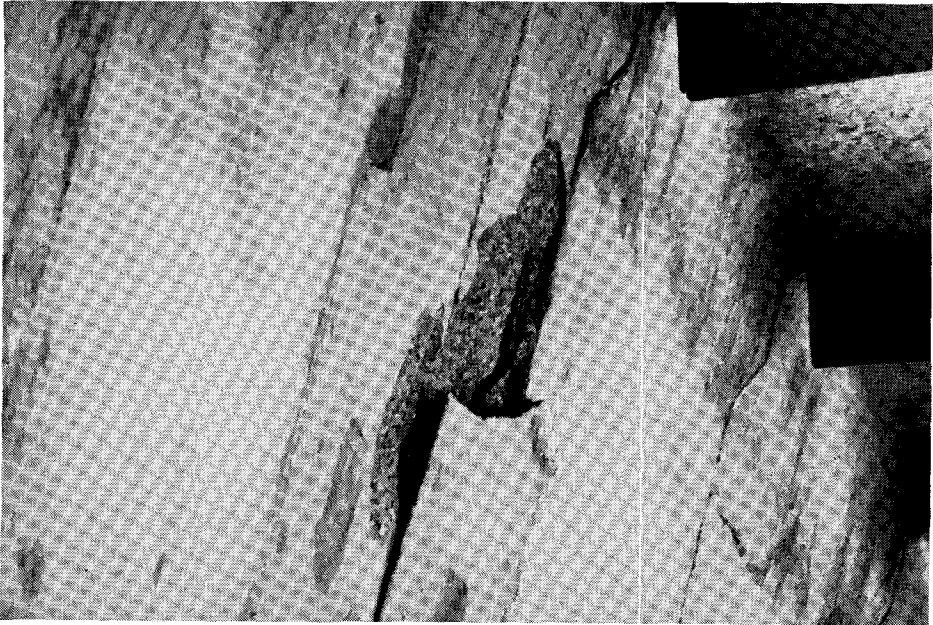

Fig. 23. Damaged web seen from outside.



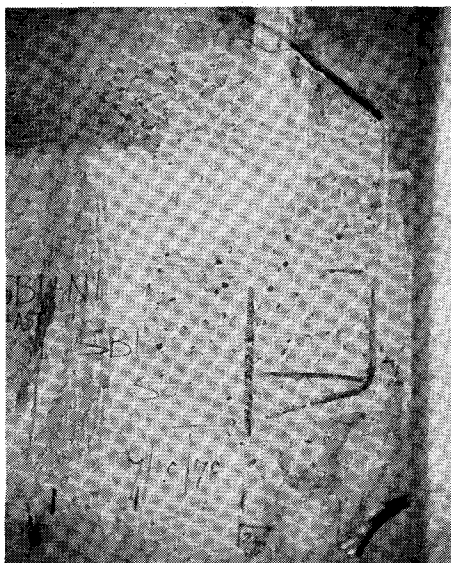

Fig. 24. Damaged key seen from inside the box girder.

not show any sharp step at the joint, not even above the east web. The relative movement at the web, combined with the absence of any noticeable movement at the top of the slab, indicated that there must be a horizontal delamination in the slab, probably in the plane of the longitudinal post-tensioning bars. This was confirmed by testing with delamination-detecting equipment.

Shortly after the distress in the girder web joint was discovered, cribbing was placed between the pier top and the girder under both webs. The cribbing is visible in Fig. 22.

### Cause of Joint Problem

The examination of conditions at the distressed joint revealed immediately that the epoxy in the joint had not hardened properly and was soft and plastic. Epoxy that had extruded out of the joint could easily be pulled off by hand and molded with the fingers. Subsequently, non-hardened epoxy was also found in a large number of other joints in the bridge.

As mentioned earlier, in the section on design details, the web keys were not designed to serve as the main shear-transfer device between segments; the keys were intended only to support the weight of a few segments during curing of the epoxy. Under greater loading, after proper curing of the epoxy, the epoxy was required to sustain a combination of shear and normal stress over the entire height of the joint. The soft epoxy that was found in the distressed joint and in many other joints was obviously incapable of sustaining any significant shear loading. The soft and viscous material could, in fact, be expected to function as a lubricant between adjacent segments, thus forcing the web keys to support the entire shear loading on the joint. The result is severe overstressing of the keys.

All observed conditions at the site of the distressed joint were completely consistent with this failure mechanism. The key and web damage was of the type that could be expected to result from overloading of the key. It is estimated that the shear force on the joint at the time of the failure was about 1500 kips (6675 kN) (750 kips at each web), which is about 65 percent of the maximum design shear loading on the joint.

### Repair Procedure

The repair or correction scheme that was devised for joints that contained non-hardened epoxy is shown in Fig. 25. This technique was developed by Alfred Benesch & Company and accepted by the contractor. (Note that the contractor had the option of proposing an alternate solution but chose to adopt the Benesch scheme.)

The correction technique consists essentially of the insertion of stainless steel pins into the joint through the thickness of the girder web, which allows shear transfer to take place by bearing on the sides of the pins. The

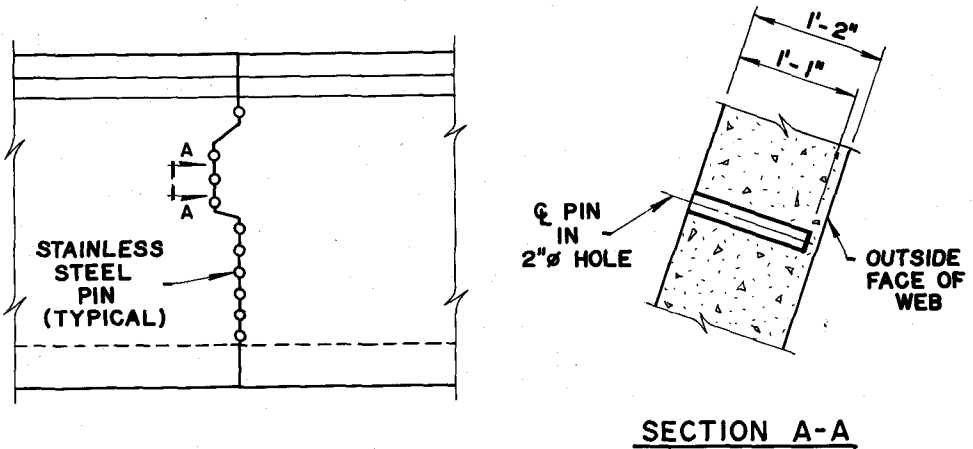

Fig. 25. Correction scheme for joints that contained non-hardened epoxy.

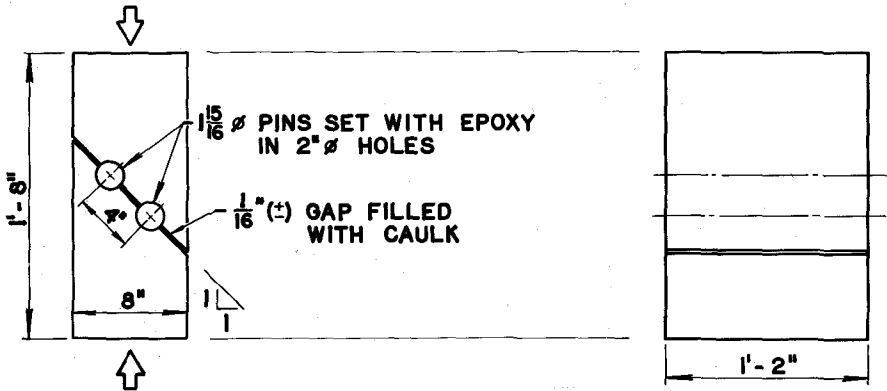

Fig. 26. Test specimen.

1.94-in. (49 mm) diameter pins are set in 2-in. (51 mm) diameter cored holes with epoxy. The number of pins required varies with the shear loading on the joint. The maximum number was determined to be 18 in each web at joints near the piers. In low-shear areas near midspan, it was determined that pinning of joints that had soft epoxy would not be required since the keys alone could support the load.

The repair design was based on an average shear transfer of about 60 kips (267 kN) per pin. To verify the appropriateness of this design value, a simple

test was conducted in IDOT's laboratories. The test specimen and method of loading are illustrated in Fig. 26. The specimen is a full-sized two-pin assembly that represents a part of a joint in a girder web. Equal shear and normal loading is imposed on the joint in the specimen. The design loading of 60 kips (267 kN) shear per pin is equivalent to a test load of 170 kips (756 kN) on the specimen.

The specimen failed at a load of 337 kips (1500 kN). Failure occurred by splitting of the concrete at a pin. This mode of failure is not possible in the



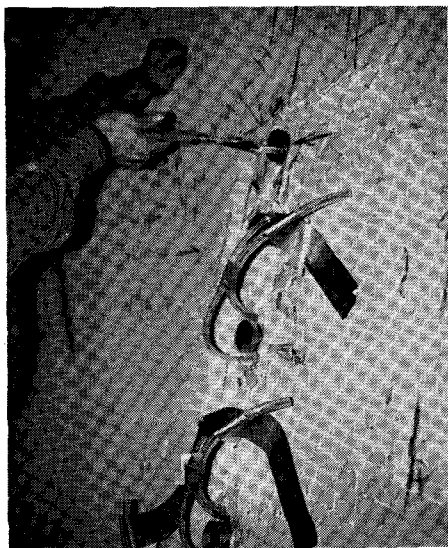

Fig. 27. Installation of pin.

actual structure. At initiation of the splitting failure, there was no indication of incipient crushing or any other mode of failure. The joint capacity — for failure modes that are possible in the bridge — could, therefore, be expected to be even higher than indicated by the test.

All joints, except those in very low-shear areas [located more than 90 ft (27.4 m) from any pier and 30 ft (9.1 m) from any abutment], were investigated for defective epoxy. This investigation included the removal of four cores from each joint for examination and testing in the laboratory. Defective epoxy was found in 81 joints. All 81 of these joints were repaired by insertion of pins. The total number of pins installed was about 1500.

One of the steps in the pin-installation procedure (insertion of the pin) is shown in Fig. 27. There were few problems during the work. At some joints, interference with reinforcing bars required that one or two pins be either eliminated or inserted only part-way into the web. All repair work was done from inside the box girder. As

shown in Fig. 25, the holes for the pins were stopped 1 in. (25.4 mm) short of the outside of the web. There was some concern that holes might break through; however, this did not turn out to be a problem. From outside the box girder, there is no evidence of the existence of the pins. The damaged web and key (Figs. 22, 23, and 24) were repaired by patching with epoxy mortar. The deck delamination above the damaged web was repaired by pressure grouting.

### Result of Repair

Following the repair of joints that were found to have non-hardened epoxy, there were no further joint problems in the bridge. The repaired bridge has been subjected to heavy loading for 2 years. Most of the segments for the second bridge were transported over the repaired structure, as were more than 2 million tons of earth fill. These loadings included numerous applications of loads greater than the design HS20 truck. There has been no indication of joint distress. The second bridge has now been completed, with no change in joint design or details. There has been no repetition of the joint problems that occurred in the first bridge.

## SUMMARY

The Kishwaukee River Bridges were the first precast segmental bridges to be built in Illinois and the first segmental bridges anywhere in the United States to be erected using a launching truss. Another significant feature of the project is that contractors were given an unusual degree of freedom to choose their own construction methods and details.

Construction had to conform to certain strict requirements for protection of the local environment. Aesthetics were an important consideration in the design of the project. Despite these constraints, the Kishwaukee bridges did

not cost the owner any more than conventional bridges of similar span lengths built with less regard for aesthetics and the environment.

In the first of the two bridges, epoxy in many of the joints between segments did not harden properly. A corrective procedure that involved installation of steel pins was carried out at these joints; this procedure was completely

successful in restoring the structure.

The Kishwaukee River Bridges have received awards from the U.S. Department of Transportation and National Endowment for the Arts (jointly), the American Consulting Engineers Council, the Prestressed Concrete Institute, and the Post-Tensioning Institute.

The bridges were opened to public use the summer of 1982.

## CREDITS

Owner: Illinois Department of Transportation.

Engineer: Alfred Benesch & Company, Chicago, Illinois.

Special Consultant: BVN/STS, Indianapolis, Indiana.

General Contractor: Edward Kraemer & Sons, Inc., Plain, Wisconsin.

Contractor's Engineer for Design Modifications: Dywidag Systems

International, USA, Inc., Lemont, Illinois.

Precast Concrete Fabricator: J. W. Peters & Sons, Burlington, Wisconsin.

Post-Tensioning Supplier: Dywidag Systems International, USA, Inc., Lemont, Illinois.

Erector: Heavy Construction Services, Belvidere, Illinois.

\* \* \*