

Flexural Strength of Prestressed Concrete Members



Brian C. Skogman

Structural Engineer
Black & Veatch
Kansas City, Missouri



Maher K. Tadros

Professor of Civil Engineering
University of Nebraska
Omaha, Nebraska



Ronald Grasmick

Structural Engineer
Dana Larson Roubal and
Associates
Omaha, Nebraska

The flexural strength theory of prestressed concrete members is well established. The assumptions of equivalent rectangular stress block and plane sections remaining plane after loading are commonly accepted. However, the flexural strength analysis of prestressed concrete sections is more complicated than for sections reinforced with mild bars because high strength prestressing steel does not exhibit a yield stress plateau, and thus cannot be modeled as an elasto-plastic material.

In 1979, Mattock¹ presented a procedure for calculating the flexural strength of prestressed concrete sections on an HP-67/97 programmable cal-

culator. His procedure consisted of the theoretically exact "strain compatibility" method and a power formula for modeling the stress-strain curve of prestressing steel. This power formula was originally reported in Ref. 2 and is capable of modeling actual stress-strain curves for all types of steel to within 1 percent.

Prior to Mattock's paper, the strain compatibility method commonly required designers to use a graphical solution for the steel stress at a given strain. There are computer programs for strain compatibility analysis (see for example Refs. 3 and 4). However, these programs were developed on main

frame computers for research purposes, and are not intended as design aids.

In this paper, the iterative strain compatibility method is coded into a user friendly program in BASIC. The program assumes a neutral axis depth, calculates the corresponding steel strains, and obtains the steel stresses by use of the power formula.² Force equilibrium ($T = C$) is checked, and if the difference is significant, the neutral axis depth is adjusted and the procedure repeated until T and C are equal. Users are allowed to input steel stress-strain diagrams with either minimum ASTM specified properties or actual experimentally obtained properties. Noncomposite and composite sections can be analyzed, and a library of common precast concrete section shapes is included.

A recent survey by the authors is reported herein. It indicates that the actual steel stress, at a given strain, could be as high as 12 percent over that of minimum ASTM values. Also, future developments might produce steel types with more favorable properties than those currently covered by ASTM standards. With sufficient documentation, precast concrete producers could use the proposed computer analysis to take advantage of these improved properties.

A second objective of this paper is to present an approximate noniterative procedure for calculating the prestressed steel stress, f_{ps} , at ultimate flexure, without a computer. The proposed procedure requires a hand held calculator with the power function y^x . Currently, such scientific calculators are inexpensive, which makes the proposed procedure a logical upgrade of the approximate procedure represented by Eq. (18-3) in the ACI 318-83 Code.⁵

The proposed approximate procedure is essentially a one-cycle strain-compatibility solution. The main approximation involves initially setting the tensile steel stresses equal to the respective

Synopsis

Flexural strength theory is reviewed and a computer program for flexural analysis by the iterative strain compatibility method is presented. It is available from the PCI for IBM PC/XT and AT microcomputers and compatibles.

Secondly, a new noniterative approximate method for hand calculation of the stress f_{ps} in prestressed tendons at ultimate flexure is presented. It is applicable to composite and noncomposite sections of any shape with any number of steel layers, and any type of ASTM steel at any level of effective prestress.

Parametric and comparative studies indicate the proposed method is more accurate and more powerful than other approximate methods. Numerical examples are provided and proposed ACI 318-83 Code and Commentary revisions are given.

yield points of the steel types used in the cross section, and setting the compressive steel stress equal to zero. Approximate steel strains are then computed from conditions of equilibrium and compatibility. The final steel stresses are obtained by substituting the strains into the power formula. However, the main advantage of this procedure over current approximate methods is its applicability to all section shapes, all effective prestress levels, and any combination of steel types in a given cross section.

The proposed approximate procedure is compared with the precise strain compatibility method and two other approximate procedures: the ACI Code method, which was developed for the Code committee by Mattock,⁶ and the method recently proposed by Harajli

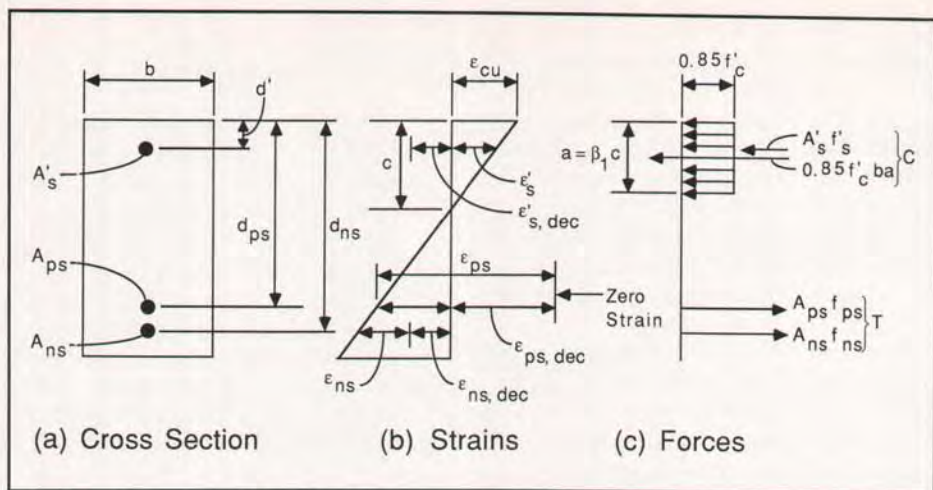

Fig. 1. Flexural strength relationships.

and Naaman.⁷ Plots of behavior of these four methods under various combinations of concrete strength and reinforcement parameters are discussed. Qualitative comparison with a recently introduced approximate method by Loov is also given. Results indicate that the proposed procedure is more accurate than the other approximate methods, and it makes better use of the actual material properties.

Numerical examples are provided to illustrate the proposed procedure and to compare it with the other approximate methods. A proposal for revision of the ACI Code and Commentary⁸ is given in Appendix B.

PROBLEM STATEMENT AND BASIC THEORY

Referring to Fig. 1, the problem may be stated as follows. Given are the cross-sectional dimensions; the prestressed, nonprestressed, and compression steel areas, A_{ps} , A_{ns} , and A'_s , respectively; the depths to these areas, d_{ps} , d_{ns} , and d' , respectively; the concrete strength f'_c and ultimate strain ϵ_{cu} ; and the stress-strain relationship(s) of

the steel. The nominal flexural strength, M_n , is required.

A procedure for obtaining the stress in prestressed and nonprestressed tendons at ultimate flexure can be developed as follows. Referring to Fig. 1(c), force equilibrium ($T = C$) may be satisfied by:

$$A_{ps}f_{ps} + A_{ns}f_{ns} - A'_s f'_s = 0.85 f'_c b \beta_1 c \quad (1)$$

where f_{ps} , f_{ns} , and f'_s are the prestressed, nonprestressed, and compression steel stresses at ultimate flexure, respectively; b is the width of the compression face; β_1 is a coefficient defining the depth of the equivalent rectangular stress block, a , in Section 10.2.7 of ACI 318-83; and c is the distance from the extreme compression fiber to the neutral axis.

If the compression zone is nonrectangular or if it consists of different concrete strengths, Eq. (1) may be rewritten as follows:

$$A_{ps}f_{ps} + A_{ns}f_{ns} - A'_s f'_s = F_c \quad (1a)$$

where F_c is the total compressive force in the concrete.

The equivalent rectangular stress distribution has been shown to be valid for nonrectangular sections,^{9,10} so the

area of concrete in compression may be determined by a consideration of the section geometry and setting the stress in each type of concrete equal to its respective $0.85 f'_c$ value.

Assuming that plane cross sections before loading remain plane after loading, and that perfect bond exists between steel and concrete, an equation can be written for the strain in steel, Fig. 1(b):

$$\epsilon_i = \epsilon_{cu} \left(\frac{d_i}{c} - 1 \right) + \epsilon_{i,dec} \quad (2)$$

where "i" represents a steel layer designation. A steel layer is defined as a group of bars or tendons with the same stress-strain properties (type), the same effective prestress, and that can be assumed to have a combined area with a single centroid.

In Eq. (2), $\epsilon_{i,dec}$ is the strain in steel layer "i" at concrete decompression. The decompression strain, $\epsilon_{i,dec}$, is a function of the initial prestress and the time-dependent properties of the concrete and steel. In lieu of a more accurate calculation,¹¹ the change in steel strain due to change in concrete stress from effective value to zero (i.e., due to concrete decompression) may be ignored. Thus, $\epsilon_{i,dec}$ may be computed as follows. If the effective prestress f_{se} is known:

$$\epsilon_{i,dec} = \frac{f_{se}}{E_i} \quad (3)$$

or if the effective prestress is unknown:

$$\epsilon_{i,dec} = \frac{f_{pi} - 25,000}{E_i} \quad (4)$$

where

E_i = modulus of elasticity of steel layer "i", psi

f_{pi} = initial stress in the tendon before losses, psi

Note that f_{pi} is equal to zero for non-prestressed tendons. The constant 25,000 psi (172.4 MPa) approximates the

prestress losses due to creep and shrinkage plus allowance for elastic rebound due to decompression of the cross section.

If the value of c from Eq. (1) is substituted into Eq. (2), then Eq. (2) becomes:

$$\epsilon_i = \epsilon_{cu} \left(\frac{0.85 f'_c b \beta_1 d_i}{A_{ps} f_{ps} + A_{ns} f_{ns} - A'_s f'_s} - 1 \right) + \epsilon_{i,dec} \quad (5)$$

With the strain ϵ_i given, the stress may be determined from an assumed stress-strain relationship, such as the one presented in the following section.

STEEL STRESS-STRAIN RELATIONSHIP

In 1979, Mattock¹ used a power equation² to closely represent the stress-strain curve of reinforcing steel (high strength tendons or mild bars). The general form of the power equation is:

$$f_i = \epsilon_i E \left[Q + \frac{1 - Q}{(1 + \epsilon_i^{*R})^{1/R}} \right] \leq f_{pu} \quad (6)$$

where

$$\epsilon_i^* = \frac{\epsilon_i E}{K f_{pu}} \quad (7)$$

and

f_i = stress in steel corresponding to a strain ϵ_i

f_{pu} = specified tensile strength of prestressing steel

and E , K , Q , and R are constants for any given stress-strain curve. In lieu of actual stress-strain curves, values of E , K , Q , and R for the steel type of steel layer "i" may be taken from Table 1, which is based on minimum ASTM standard properties.

The values of E , K , Q , and R in Table 1 were determined by noting that the yield point (ϵ_{py} , f_{py}) and the ultimate strength point (ϵ_{pu} , f_{pu}) must satisfy Eq. (6), where ϵ_{py} , f_{py} , and f_{pu} are the

Table 1. Tendon steel stress-strain constants for Eq. (6).

f_{pu} (ksi)	f_{py}/f_{pu}	E (psi)	K	Q^*	R
270 strand	0.90	28,000,000	1.04	0.0151	8.449
	0.85	28,000,000	1.04	0.0270	6.598
250 strand	0.90	28,000,000	1.04	0.0137	6.430
	0.85	28,000,000	1.04	0.0246	5.305
250 wire	0.90	29,000,000	1.03	0.0150	6.351
	0.85	29,000,000	1.03	0.0253	5.256
235 wire	0.90	29,000,000	1.03	0.0139	5.463
	0.85	29,000,000	1.03	0.0235	4.612
150 bar	0.85	29,000,000	1.01	0.0161	4.991
	0.80	29,000,000	1.01	0.0217	4.224

Note: 1 ksi = 1000 psi = 6.895 MPa.

* Q is based on $\epsilon_{pu} = 0.05$.

minimum ASTM standard values for the steel type used. A value of $\epsilon_{pu} = 0.05$ was used for all prestressing steel types, rather than the ASTM specified minimum ultimate strain of 0.035 or 0.04. This is a conservative assumption based on experimental results; its adoption results in lower stress values at intermediate strains.

Other assumptions were necessary to solve for the constants E , K , Q , and R . These assumptions were made on the basis of experience gained from the shape of experimental stress-strain curves reported in Refs. 1 and 12, and in a separate section of this paper.

STRAIN COMPATIBILITY APPROACH AND COMPUTER PROGRAM

The strain compatibility method usually requires an iterative numerical solution because of the interrelation of the

unknown parameters. A step-by-step application^{3,13} of this method is described as follows:

Step 1: Assume a compression block depth, a , and compute the neutral axis depth, c .

Step 2: Substitute c into Eq. (2) to obtain the strain for each steel layer in the section.

Step 3: Estimate the stress in each steel layer by use of a graphical or analytical stress-strain relationship.

Step 4: Check satisfaction of the equilibrium formula, Eq. (1a).

Step 5: If Eq. (1a) is not satisfied, repeat Steps 1 through 4 with a new value of a .

Step 6: When compatibility, Eq. (2), and equilibrium, Eq. (1a), are achieved simultaneously, determine the flexural strength, M_n .

The aforementioned steps were used to develop a user-friendly flexural strength analysis program.¹⁴ The program can analyze noncomposite and

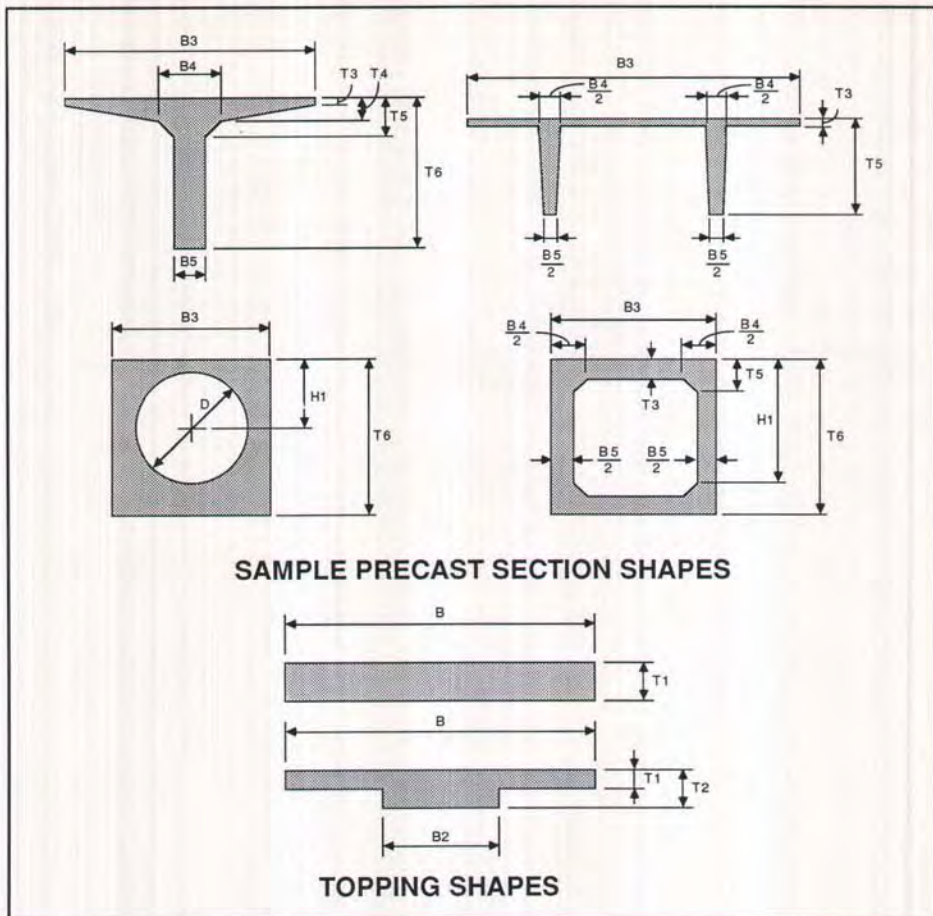

Fig. 2. Sample precast section shapes and topping shapes available with the strain compatibility computer program.

composite members. Users can choose from twelve common precast section shapes and combine the selected section with either of the two available topping shapes (rectangular or tee) to form a composite member. Four of the precast section shapes and the two topping shapes are shown in Fig. 2 as examples. Obviously, analysis is equally valid for cast-in-place members constructed in one or two stages.

Fully prestressed and partially prestressed members with bonded reinforcement can be analyzed, and any number of steel types or steel layers can

be specified. Properties for any steel type can be taken from twelve types of steel, built into the program, that meet ASTM minimum standards. Ten of these types are given in Table 1, and the other two are Grades 60 (413.7 MPa) and 40 (275.8 MPa) mild bars. Alternatively, properties for any steel type can be assigned on the basis of adequately documented manufacturer supplied records.

Steel stresses are computed by Eq. (6) and force equilibrium is achieved by selecting progressively smaller increments of a . Any system of units may be used. All input data can be edited as

many times as needed. This allows use of the program for either analysis or design.

The program package is available from the PCI for a nominal charge. The package includes a 5.25 in. (133 mm) diskette, and a manual containing instructions, section shapes, and examples with input/output printout.

Actual Versus Assumed Steel Stress-Strain Curves

In researching their paper, the authors solicited stress-strain curves from tendon suppliers and manufacturers. Seventy curves were received and their breakdown is as follows: 19 curves of Grade 270 ksi (1862 MPa) stress-relieved strand, 23 curves of Grade 270 ksi low-relaxation strand, 13 curves of Grade 250 ksi (1724 MPa) low-relaxation strand, and 15 miscellaneous curves consisting of stress-relieved or low-relaxation wire of varying strengths and 0.7 in. (17.8 mm) diameter ASTM A779

Table 2. Manufacturer legend for stress-strain curves in Figs. 3, 4 and 5.

CURVE	MANUFACTURER/SUPPLIER
A	ARMCO INC.
BL, BU*	FLORIDA WIRE AND CABLE CO.
C	PRESTRESS SUPPLY INC.
D	SHINKO WIRE AMERICA INC.
E	SIDERIUS INC.
F	SPRINGFIELD INDUSTRIES CORP.
G	SUMIDEN WIRE PRODUCTS CORP.

* Curve BL represents a lower bound of 10 curves and curve BU represents an upper bound of the same 10 curves.

prestressing strand.

Six curves for Grade 270 ksi stress-relieved strand, six curves for Grade 270 ksi low-relaxation strand, and two curves for Grade 250 ksi low-relaxation strand were considered representative of the data received. These curves are reproduced in Figs. 3, 4, and 5, respectively, and a manufacturer legend is given in Table 2. Differences in the

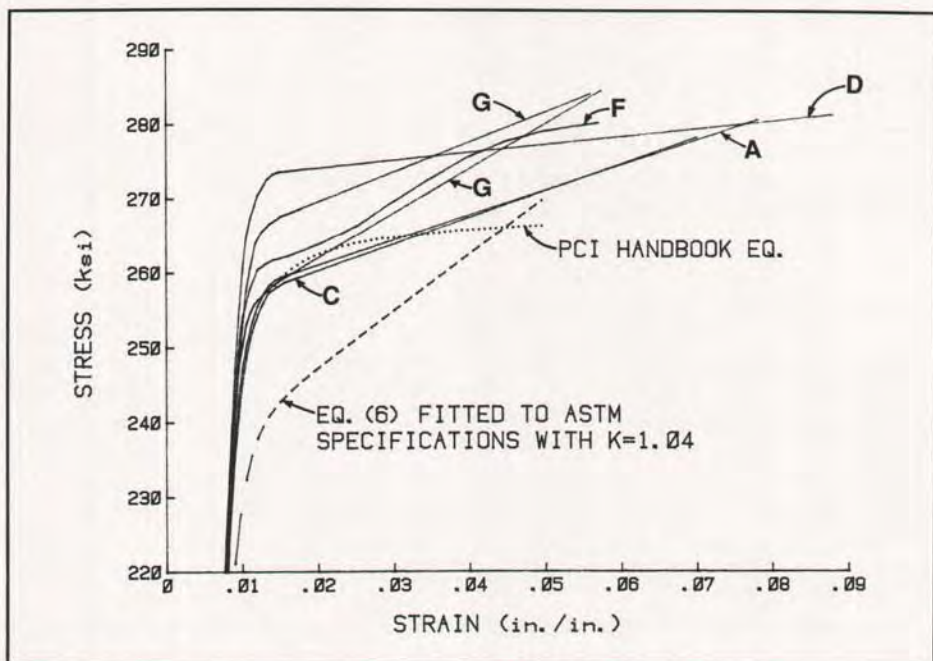

Fig. 3. Manufacturer stress-strain curves for ASTM A416, 270 ksi, 7-wire, stress-relieved strand.

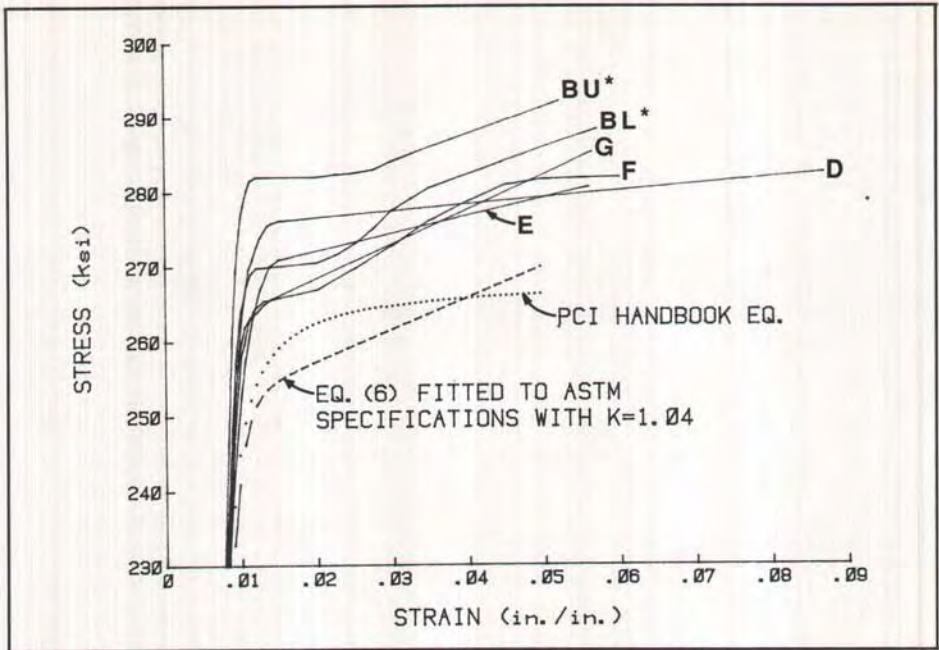

Fig. 4. Manufacturer stress-strain curves for ASTM A416, 270 ksi, 7-wire, low-relaxation strand.

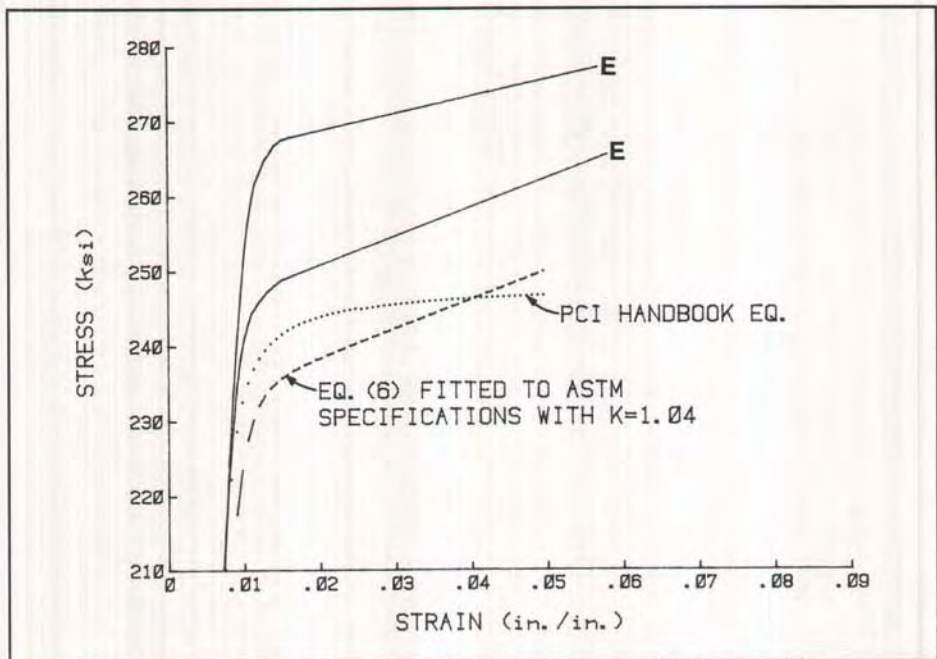

Fig. 5. Manufacturer stress-strain curves for ASTM A416, 250 ksi, 7-wire, low-relaxation strand.

shape of the curves beyond the yield strain, $\epsilon_{py} = 0.01$, are attributable to an absence of data for Curves A, C, D, E, and G for strains greater than 0.015 and less than the ultimate strain, ϵ_{pu} , and for Curves BL and BU for strains greater than 0.035 and less than ϵ_{pu} .

The figures also show plots of the PCI Design Handbook¹⁵ equations and Eq. (6) set to ASTM minimum specifications. For convenience, the PCI Design Handbook equations are reproduced here.

$$\text{If } \epsilon_{ps} \leq 0.008 \text{ then } f_{ps} = 28,000 \epsilon_{ps} \text{ (ksi)} \quad (8)$$

If $\epsilon_{ps} > 0.008$:
For 250 ksi (1724 MPa) strand:

$$f_{ps} = 248 - \frac{0.058}{\epsilon_{ps} - 0.006} < 0.98 f_{pu} \text{ (ksi)} \quad (9)$$

For 270 ksi (1862 MPa) strand:

$$f_{ps} = 268 - \frac{0.075}{\epsilon_{ps} - 0.0065} < 0.98 f_{pu} \text{ (ksi)} \quad (10)$$

The figures show that the minimum ASTM curves are very conservative. The PCI Design Handbook equations plot closer to the actual curves; however, they are slightly unconservative in two cases in Fig. 5.

Eq. (6) was used to model each manufacturer curve in Figs. 3, 4, and 5. The percent deviation between each manufacturer curve and its corresponding Eq. (6) version was computed for $\epsilon = 0$ to ϵ_{pu} . The maximum percent deviation for each type of strand for $\epsilon > 0$ and $\epsilon \geq 0.01$ is shown in Table 3, Part (a). The results of similar analyses for the PCI Design Handbook equations and Eq. (6) set to ASTM minimum specifications are shown in Table 3, Parts (b) and (c), respectively.

Table 3, Part (a) reveals that very small errors are obtained when Eq. (6) is

fitted to a given manufacturer's curve. This is in close agreement with Mattock's¹ and Naaman's⁴ findings. The PCI Design Handbook equations and the minimum ASTM Standard values can underestimate the steel stress by as much as 10.82 and 12.31 percent, respectively.

Prestressed concrete producers tend to buy their tendons from a limited number of manufacturers. Therefore, they are in a position to take advantage of higher tendon capacities with adequate documentation of the actual stress-strain curves and use of the aforementioned computer program.

Proposed Approximate Method

The proposed approximate method is essentially one cycle of the iterative strain compatibility approach. In order to get accurate results at the end of one cycle, initial parameters must be carefully selected. It is difficult to assume an accurate initial value for the neutral axis depth, c , due to its wide variation. Rather, the steel stresses are initially assumed to be at the yield point for the tensile reinforcement, and at zero for the compressive reinforcement. These initial assumptions are based on numerous trials and parametric studies discussed in a separate section.

The proposed approximate method can be performed by using the following steps:

Step 1: Set $f_{ps} = f_{py}$, $f_{ns} = f_{py}$ or f_y , and $f'_s = 0$ in Eq. (1a) and compute the total compressive force in the concrete, F_c .

$$A_{ps} f_{ps} + A_{ns} f_{ns} - A'_s f'_s = F_c \quad (1a)$$

Step 2: Set the quantity F_c equal to $0.85 f'_c A_c$, where A_c is the area in compression for a type of concrete, and solve for the compression block depth, a . For composite sections, there are as many $0.85 f'_c A_c$ terms as the number of types of concrete in compression.

Step 3: Compute the depth of the neutral axis $c = a/\beta_1$. For composite

Table 3. Maximum percent deviation between manufacturer stress-strain curves and a reference curve.

REFERENCE CURVE	TYPE OF STRAND ^a					
	270 KSI ^b STRESS-RELIEVED		270 KSI ^c LOW-RELAXATION		250 KSI ^d LOW-RELAXATION	
	$\epsilon > 0$	$\epsilon \geq 0.01$	$\epsilon > 0$	$\epsilon \geq 0.01$	$\epsilon > 0$	$\epsilon \geq 0.01$
(a) EQ. (6) FITTED TO MANUFACTURER CURVE	-0.79 ^e	-0.79	-1.36	-1.36	-1.65	-0.77
(b) PCI HANDBOOK EQUATIONS	-6.34	-6.34	-10.82	-10.82	-7.63	-3.81
(c) EQ. (6) SET TO ASTM MINIMUM STANDARDS K=1.04	-12.21	-12.21	-12.31	-12.12	-11.96	-11.96

Note: 1 ksi = 6.895 MPa.

^aAll strand is ASTM A416; ^b6 curves, see Fig. 3; ^c6 curves, see Fig. 4; ^d2 curves, see Fig. 5; ^ea negative value indicates the stress by the reference curve is less than the actual stress.

sections, assume an average β_1 as follows:

$$\beta_1 \text{ ave.} = \frac{\sum_k 0.85 (f'_c A_c \beta_1)_k}{F_c} \quad (11)$$

where k is the concrete type number.

Step 4: Compute the strain in each steel layer "i" by Eq. (2). In general, mild tension reinforcement, if any, yields for practical applications. Thus, Step 4 may be omitted for this type of steel.

$$\epsilon_i = \epsilon_{cu} \left(\frac{d_i}{c} - 1 \right) + \epsilon_{i,dec} \quad (2)$$

where

$$\epsilon_{i,dec} = \frac{f_{se}}{E_i} \quad (3)$$

or

$$\epsilon_{i,dec} = \frac{f_{pi} - 25,000}{E_i} \quad (4)$$

whichever is applicable. For nonprestressed steel $f_{pi} = 0$.

Step 5: Compute the stress in each steel layer a "i" by use of Table 1 and Eqs. (6) and (7):

$$f_i = \epsilon_i E \left[Q + \frac{1 - Q}{(1 + \epsilon_i^{*R})^R} \right] \leq f_{pu} \quad (6)$$

and

$$\epsilon_i^* = \frac{\epsilon_i E}{K f_{pu}} \quad (7)$$

Note for mild reinforcement, it is easier to use the relationship $f_i = \epsilon_i E \leq f_y$, than to apply Eqs. (6) and (7).

Step 6: With the steel stresses at ultimate flexure known, apply the standard equilibrium relationships to get the flexural capacity, M_n .

To illustrate the above procedure, two numerical examples are worked out on the next few pages.

NUMERICAL EXAMPLES

Two numerical examples are now shown to illustrate the calculation of the nominal moment capacity using the proposed method and to compare the results with existing analytical methods. In the first example (a precast inverted T-beam with cast-in-place topping), the proposed moment capacity is compared

with the value obtained using the strain compatibility method. In the second example (a precast inverted T-beam without topping), the proposed moment capacity is compared with the results obtained using the ACI 318-83 Code method, the Harajli-Naaman method, and the strain compatibility method.

EXAMPLE 1

The nominal moment capacity of the T-beam shown in Fig. 6 is calculated by the proposed approximate method and the strain compatibility method.

Given: f'_c (precast) = 5 ksi (34.5 MPa), f'_c (topping) = 4 ksi (27.6 MPa). Reinforcement is 20 - 1/2 in. (12.7 mm) diameter 270 ksi (1862 MPa) low-relaxation prestressed strands, $A_{ps} = 3.06 \text{ in.}^2$ (1974 mm²), and $f_{se} = 162 \text{ ksi}$ (1117 MPa); 4 - 1/2 in. (12.7 mm) diameter 270 ksi (1862 MPa) low-relaxation nonprestressed strands, $A_{ns} = 0.612 \text{ in.}^2$ (395 mm²).

Solution:

1. Proposed method

Step 1: From Eq. (1a):

$$F_c = 3.06(0.9)270 + 0.612(0.9)270 = 892.30 \text{ kips (3969 kN)}$$

Step 2: Compute depth of stress block a .

$$0.85(4)(56)(2.5) + 0.85(5)(16)(a - 2.5) = 892.30$$

$$a = 8.62 \text{ in. (218.9 mm)} > 2.5 \text{ in. (63.5 mm)} \text{ (ok)}$$

Step 3: Compute average β_1 from Eq. (11).

$$\beta_{1 \text{ ave.}} = \frac{0.85(4)(56)(2.5)0.85}{892.30} + \frac{0.85(5)(16)(8.62 - 2.5)0.80}{892.30} = 0.83$$

$$c = a/\beta_1 = 8.62/0.83 = 10.39 \text{ in. (263.9 mm)}$$

Step 4: Compute strains in prestressed and nonprestressed steel.

From Eqs. (3) and (2):

$$\epsilon_{ps, dec} = 162/28,000 = 0.00578 \text{ and}$$

$$\epsilon_{ps} = 0.003 \left(\frac{35.8}{10.39} - 1 \right) + 0.00578 = 0.01312$$

Similarly, from Eqs. (4) and (2):

$$\epsilon_{ns, dec} = -0.00089 \text{ and } \epsilon_{ns} = 0.00607$$

Step 5: Compute stress in prestressed steel.

From Table 1:

$$E = 28,000 \text{ ksi (193,060 MPa)}$$

$$K = 1.04$$

$$Q = 0.0151$$

$$R = 8.449$$

From Eqs. (7) and (6):

$$\epsilon_{ps}^* = \frac{0.01312(28,000)}{1.04(0.9)270} = 1.4536$$

$$f_{ps} = 0.01312(28,000) \left[0.0151 + \frac{1 - 0.0151}{(1 + 1.4536^{8.449})^{1/8.449}} \right] = 253.23 \text{ ksi (1746 MPa)}$$

Similarly, $\epsilon_{ns}^* = 0.6725$ and

$$f_{ns} = 169.28 \text{ ksi (1167 MPa)}$$

Step 6: Substituting the values of f_{ps} and f_{ns} into Eq. (1a) yields:

$$F_c = 878.48 \text{ kips (3907 kN)}$$

Corresponding $a = 8.42 \text{ in. (213.9 mm)}$

Taking moments about mid-thickness of the flange yields:

$$M_n = A_{ps}f_{ps} \left(d_{ps} - \frac{h_f}{2} \right) + A_{ns}f_{ns} \left(d_{ns} - \frac{h_f}{2} \right) - 0.85f'_{c, pc}b_w(a - h_f) \left(\frac{a}{2} \right) = 2377 \text{ kip-ft (3223 kN-m)}$$

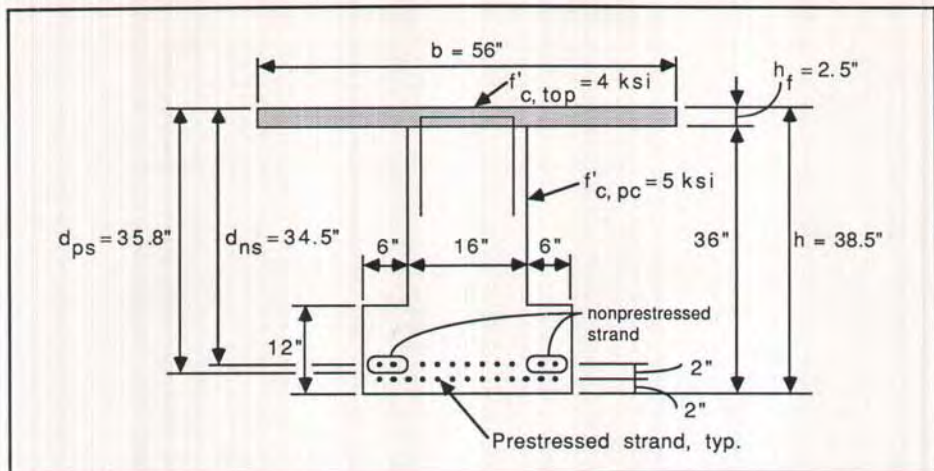

Fig. 6. Precast inverted T-beam with cast-in-place topping for Example 1.

2. Strain compatibility

Analysis by the aforementioned computer program yields:

$$f_{ps} = 253.41 \text{ ksi (1747 MPa)}$$

$$f_{ns} = 173.23 \text{ ksi (1194 MPa) and}$$

$$M_n = 2383 \text{ kip-ft (3231 kN-m)}$$

Therefore, the proposed method gives answers that are very close to those of the strain compatibility analysis. The other approximate methods are not capable of calculating tendon stresses in sections containing both prestressed and nonprestressed tendons.

EXAMPLE 2

The nominal moment capacity of the precast inverted T-beam shown in Fig. 7 is calculated by the proposed method,

the ACI 318-83 Code method, Harajli and Naaman's method, and the strain compatibility method. A discussion of the features of the other two approxi-

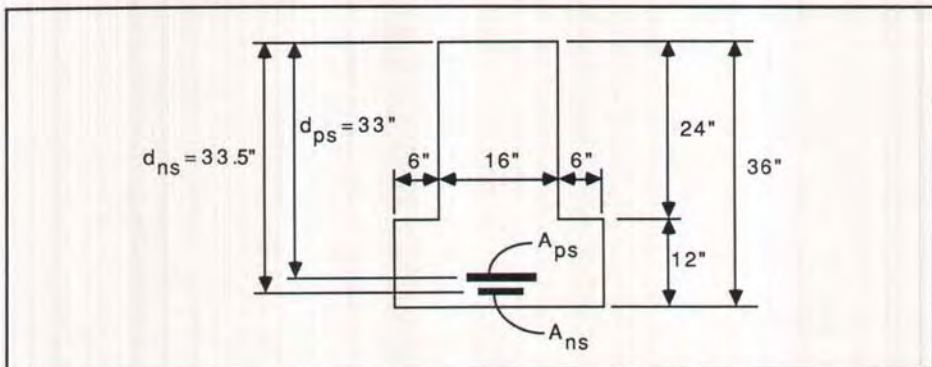

Fig. 7. Precast inverted T-beam for Example 2.

Table 4. Summary of results for Examples 1 and 2.

METHOD	PARAMETER	EXAMPLE			
		1		2	
		VALUE	PERCENT* DIFFERENCE	VALUE	PERCENT* DIFFERENCE
STRAIN COMPATIBILITY	f_{ps} (ksi)	253.41	0	247.91	0
	f_{ns} (ksi)	173.23	0	60	0
	M_n (kip-ft)	2383	0	791	0
PROPOSED METHOD	f_{ps} (ksi)	253.23	-0.07	248.80	+0.4
	f_{ns} (ksi)	169.28	-2.3	60	0
	M_n (kip-ft)	2377	-0.2	793	+0.2
ACI 318-83	f_{ps} (ksi)	NA**	NA	254.11	+2.5
	f_{ns} (ksi)	NA	NA	60	0
	M_n (kip-ft)	NA	NA	805	+1.8
HARAJLI & NAAMAN	f_{ps} (ksi)	NA	NA	256.50	+3.5
	f_{ns} (ksi)	NA	NA	60	0
	M_n (kip-ft)	NA	NA	810	+2.4

Note: 1 ksi = 6.895 MPa; 1 kip-ft = 1.356 kN-m.

* Relative to the strain compatibility analysis.

** Not applicable.

mate methods is given in the next section.

Given: $f'_c = 5$ ksi (34.5 MPa). Reinforcement is 6 - 1/2 in. (12.7 mm) diameter 270 ksi (1862 MPa) stress-relieved prestressed strands, $A_{ps} = 0.918$ in.² (592.2 mm²), $f_{se} = 150$ ksi (1034 MPa); 2 - #7 (22.2 mm) Grade 60 (414 MPa) bars, $A_{ns} = 1.20$ in.² (774.2 mm²).

Solution:

1. Proposed method

Decompression strain in prestressed steel:

$$\epsilon_{ps,dec} = 0.00536 \text{ and strain, } \epsilon_{ps} = 0.0220$$

Stress in prestressed steel:

$$f_{ps} = 248.80 \text{ ksi (1715 MPa)}$$

Corresponding nominal flexural capacity:

$$M_n = 793 \text{ kip-ft (1075 kN-m)}$$

2. ACI Code method⁵

$$f_{ps} = 254.11 \text{ ksi (1752 MPa) and}$$

$$M_n = 805 \text{ kip-ft (1092 kN-m)}$$

3. Harajli and Naaman's method⁷

Compute depth to center of tensile force, assuming $f_{ps} = f_{pu}$, $d_u = 33.89$ in. (860.8 mm).

Neutral axis depth, $c = 5.65$ in. (143.5 mm) and $f_{ps} = 256.50$ ksi (1769 MPa).

Depth to center of tensile force:

$$d_e = 33.88 \text{ in. (860.5 mm) and}$$

$$M_n = 810 \text{ kip-ft (1098 kN-m)}$$

4. Strain compatibility

Analysis by aforementioned computer program yields:

$$f_{ps} = 247.91 \text{ ksi (1709 MPa)}$$

$$f_{ns} = 60 \text{ ksi (413.7 MPa) and}$$

$$M_n = 791 \text{ kip-ft (1072 kN-m)}$$

A summary of the results of Examples 1 and 2 is given in Table 4. It shows that all three approximate methods give reasonable accuracy for the section considered in Example 2; however, the proposed method has a slight edge. A major advantage of the proposed method is its wide range of applicability, as demon-

Table 5. Parameters used in developing Figs. 8 through 16.

	TYPE OF BEAM ^a									
	RECTANGULAR							TEE		
Figure No.	8	9	10	11	12	13	14	15 ^b	16 ^c	
f'_c (ksi)	5	5	7	5	5	5	5	7	5/3 ^d	
Grade of A_{NS} (ksi)	N/A	60	60	60	270	270	N/A	N/A	60	
A_{NS}/A_{ps}	0	2	2	2	0.5	0.5	0	0	0.5	
f_{py}/f_{pu}	0.85	0.85	0.85	0.9	0.85	0.85	0.85	0.85	0.9	
d_{ns}/d_{ps}	N/A	1	1	1	1	1	N/A	N/A	1.04	
f_{se}/f_{pu}	0.56	0.56	0.56	0.56	0.56	0.56	VARIABLE	0.56	0.56	
$f_{ns,e}$ (ksi)	N/A	-2.5	-2.5	-2.5	-2.5	-2.5	N/A	N/A	-2.5	

Note: 1 ksi = 6.895 MPa.

^aFor all beams: $E_{ps} = E_{ns} = 28,000$ ksi, $A'_s = 0$, $\epsilon_{cu} = 0.003$, $\epsilon_{pu} = 0.05$, $f_{pu} = 270$ ksi.

^bTypical 8 ft. x 24 in. PCI Double Tee.

^cSection dimensions correspond to beam in Example 4.2.6 of Ref. 15.

^dprecast/topping strength.

strated by Example 1, and further discussed in the following sections.

Parametric Studies

The proposed approximate method includes assumption of initial values for the steel stresses. Numerous trials were made, for a wide range of applications, with initial steel stresses varying from f_{pu} to well below f_{pu} . It was found that the best accuracy was achieved by assuming the tensile steel stresses equal to the respective yield points of the steel types used, and the compressive steel stress equal to zero. The following discussion of Figs. 8 through 16 further illustrates this finding.

Sample plots of the results of the proposed method, the strain compatibility method, Eq. (18-3) of ACI 318-83,⁵ and Eqs. (21), (22), and (24) of Harajli and Naaman⁷ are shown in Figs. 8 through 16. A summary of the concrete and reinforcement parameters used in de-

veloping Figs. 8 through 16 is given in Table 5. Loov¹⁶ has recently proposed an approximate method. Unfortunately, the final draft of Loov's paper was not available in time to include his method in Figs. 8 through 16. For readers' convenience, the methods of Refs. 5, 7, and 16 are summarized in the following section. In addition, their main features are compared with those of the proposed approximate method.

For the parameters considered in Figs. 8 through 11, all three approximate methods are applicable. The proposed method plots within about 1.5 percent of the strain compatibility curve, and it performs better than Eq. (18-3) of ACI 318-83 and Harajli and Naaman's method. In Figs. 9 through 11, f_{ns} was taken equal to f_y in the proposed method because the mild reinforcement yields before the prestressed reinforcement reaches f_{ps} .

Figs. 12 and 13 show the relationship between steel stress at ultimate flexure

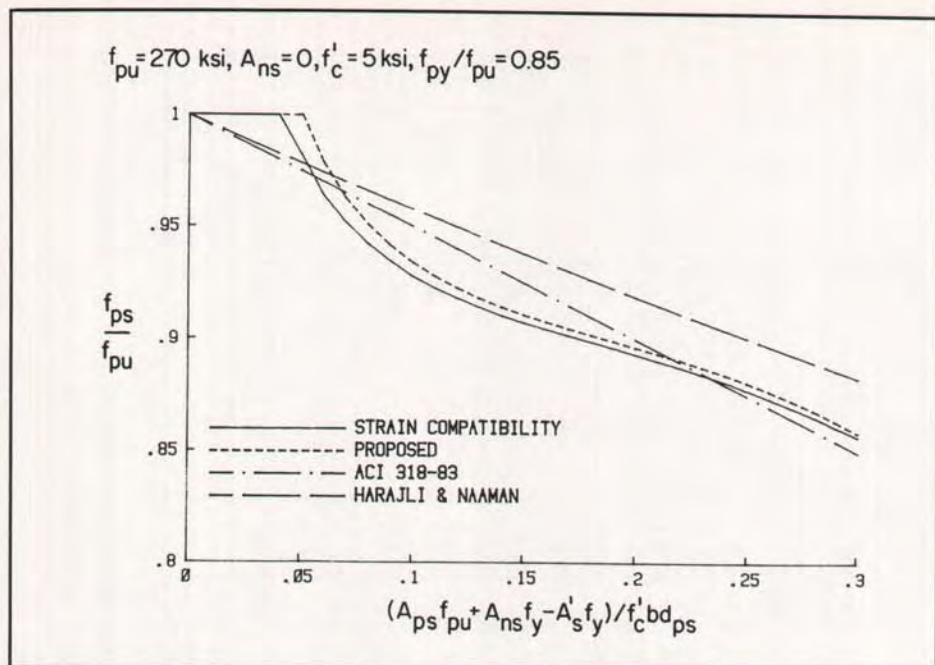

Fig. 8. Stress in prestressed tendon at ultimate flexure vs. total steel index.

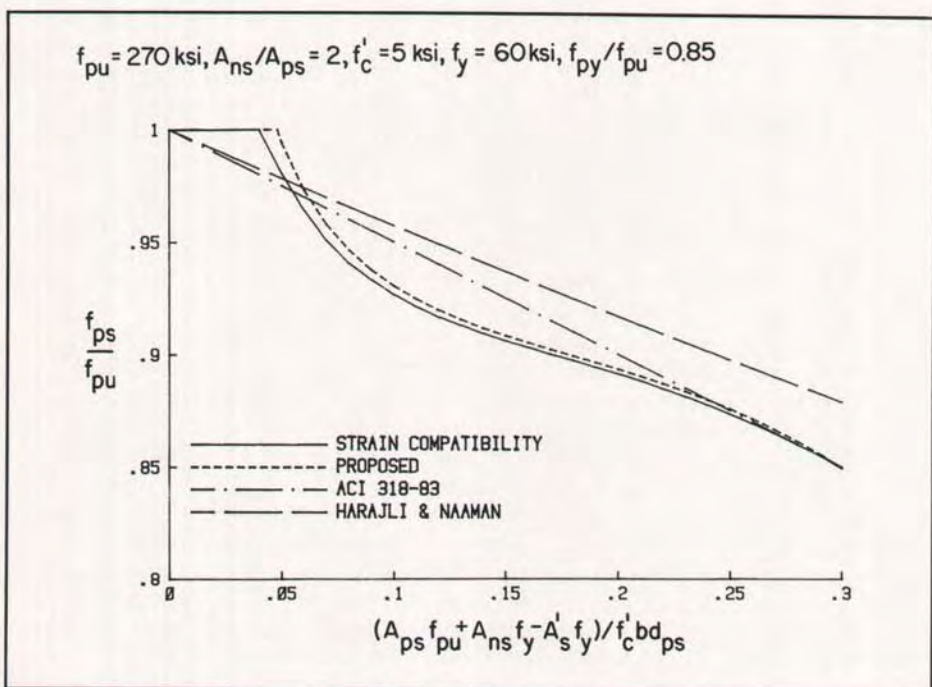

Fig. 9. Stress in prestressed tendon at ultimate flexure vs. total steel index.

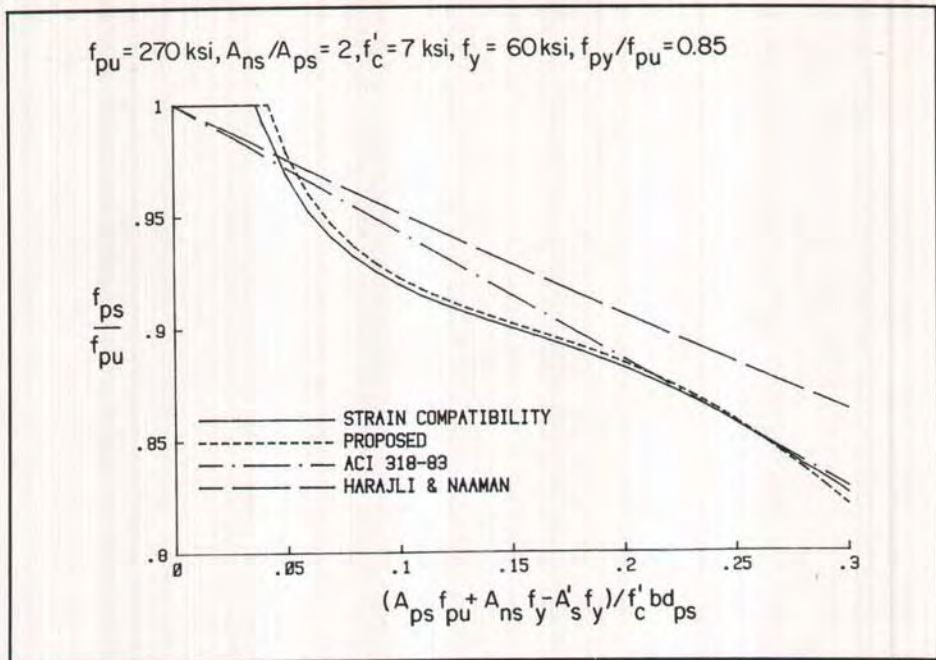

Fig. 10. Stress in prestressed tendon at ultimate flexure vs. total steel index.

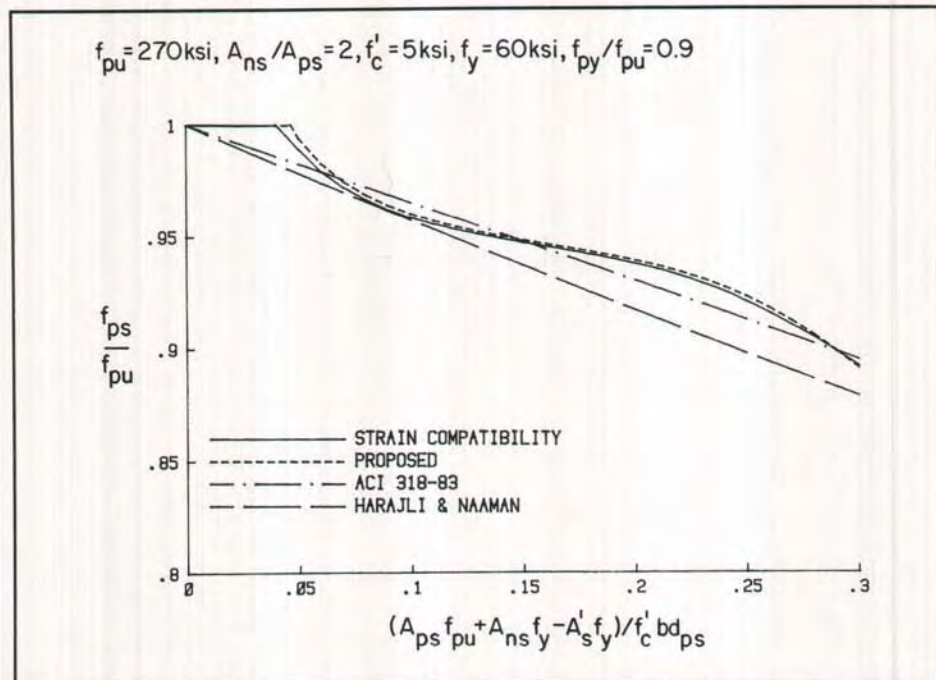

Fig. 11. Stress in prestressed tendon at ultimate flexure vs. total steel index.

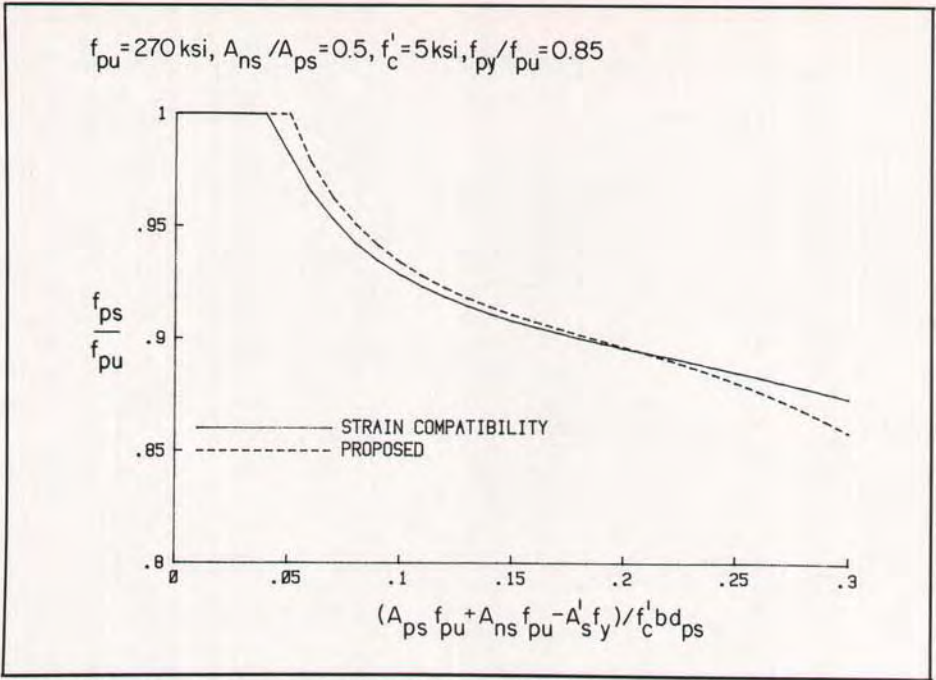

Fig. 12. Stress in prestressed tendon at ultimate flexure vs. total steel index.

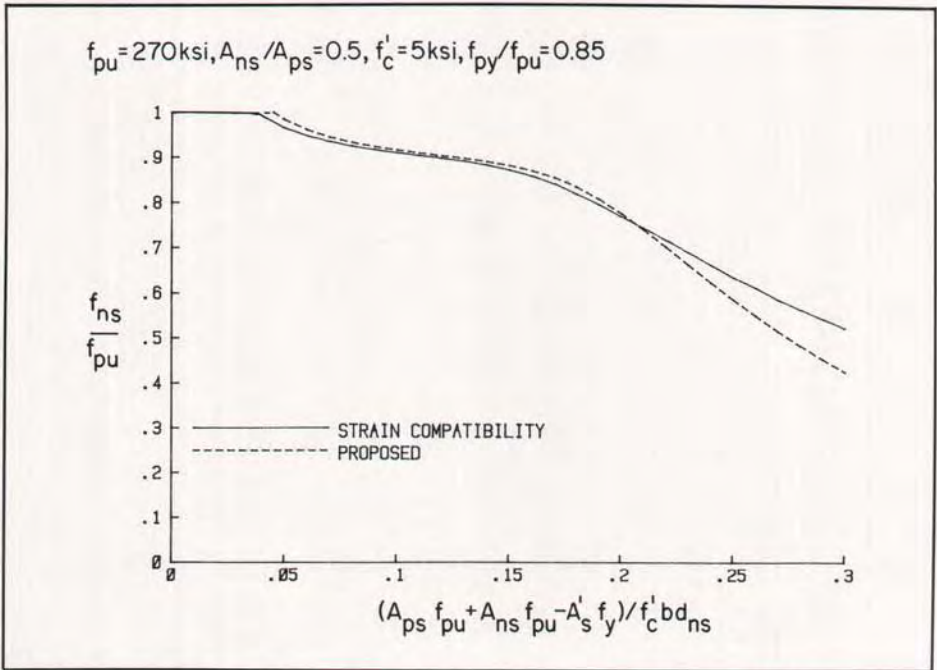

Fig. 13. Stress in nonprestressed tendon at ultimate flexure vs. total steel index.

$$f_{pu} = 270 \text{ ksi}, f'_c = 5 \text{ ksi}, f_{py}/f_{pu} = 0.85, A_{ns} = 0, (A_{ps} f_{pu}/f'_c b d_{ps}) = 0.15$$

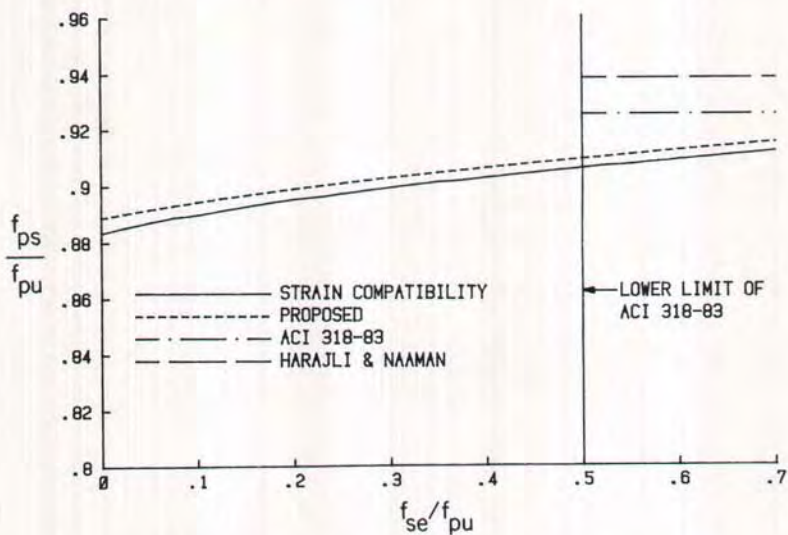

Fig. 14. Stress in prestressed tendon at ultimate flexure vs. effective prestress.

$$f_{pu} = 270 \text{ ksi}, A_{ns} = 0, f'_c = 7 \text{ ksi}, f_{py}/f_{pu} = 0.85, b/b_{w, \text{top}} = 8.35,$$

$$h_f/h = 0.083$$

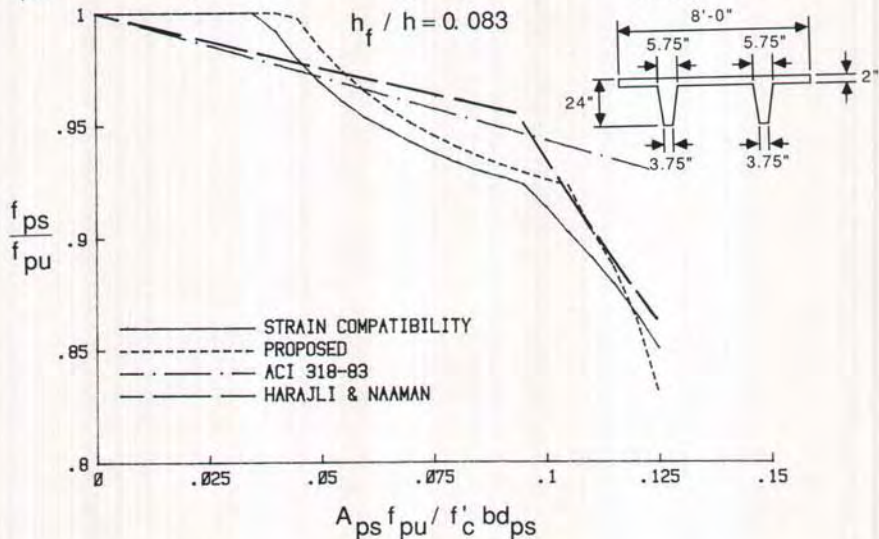

Fig. 15. Stress in prestressed tendon at ultimate flexure vs. prestressed steel index for a typical 8 ft x 24 in. PCI double T-section.

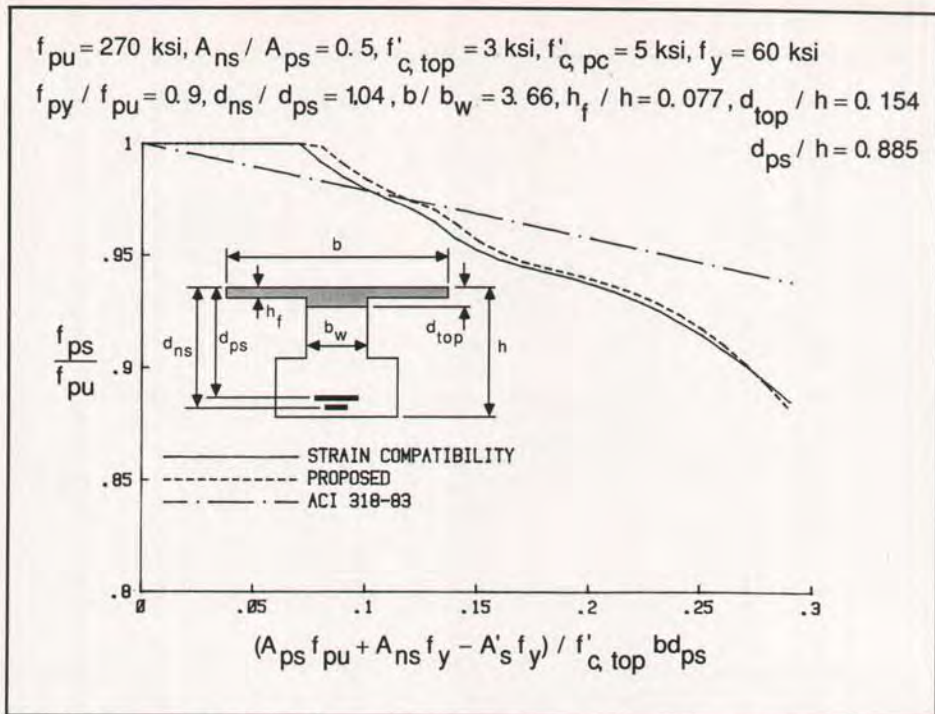

Fig. 16. Stress in prestressed tendon at ultimate flexure vs. total steel index for a composite T-section.

and total reinforcement index when prestressed tendons are supplemented with nonprestressed tendons. In this case, neither Eq. (18-3) of ACI 318-83 nor Harajli and Naaman's method is applicable. In Fig. 12, the proposed curve has a maximum deviation of about 1.5 percent. In Fig. 13, the proposed curve deviates by no more than about 2 percent in the lower two-thirds of the reinforcement range, which is where most practical designs would fall. It yields very conservative stress values in the upper third.

Fig. 14 shows the relationship between prestressed steel stress at ultimate flexure and effective prestress f_{se} , when the reinforcement index is held constant. The steel stress by the proposed method is in close agreement with the strain compatibility method for all values of effective prestress. The

other approximate methods for determining f_{ps} are limited to cases where the effective prestress is not less than $0.5 f_{pu}$.

Figs. 15 and 16 show the relationship between prestressed steel stress at ultimate flexure and total reinforcement index for T-sections. In both figures the proposed method offers better results than the other approximate methods. It should be noted from Fig. 15 that the ACI Code method becomes increasingly unconservative as the depth of the compression block, a , exceeds the flange thickness, h_f . Harajli and Naaman's method correctly adjusts for this T-section effect.

In Fig. 16, Harajli and Naaman's method was omitted because their equations do not explicitly show how to calculate f_{ps} when the depth of the compression block, a , includes more than

one concrete strength. An example in their paper, however, indicates how to apply the assumptions of their method to composite members. If their method were included in Fig. 16, it would indicate trends similar to those shown in Fig. 15.

At this point, an important observation concerning the proposed method can be made. Although the proposed method is slightly unconservative, in some cases, with respect to the strain compatibility method in Figs. 8-16, it must be noted that these figures are based on steel with minimum ASTM properties. In reality, steel properties are significantly greater than minimum ASTM properties, as discussed earlier.

Comparison of Approximate Methods

A description of four approximate procedures for calculation of f_{ps} at ultimate flexure is given in Table 6. Discussion of the features of these methods is given in Table 7. It is shown that the main advantage of the proposed procedure is its flexibility. It is applicable to current material and construction technology, as well as possible future developments.

The ACI Code method is reasonably accurate and simple to use if the compression block is of constant width. Use of steel indexes can be confusing for nonrectangular section shapes. An improvement of the current form was suggested by Mattock, in his discussion of Ref. 7, as follows:

$$f_{ps} = f_{pu} \left(1 - 0.85 \gamma_p \frac{c_u}{d_p} \right) \quad (12)$$

where c_u is the neutral axis depth calculated assuming $f_{ps} = f_{pu}$.

This modified form would combine the benefits of both the ACI Code and Harajli and Naaman's method. The authors agree with Mattock's statement that the use of d_p , rather than d_u or d_e as suggested in Ref. 7, is more theoretically correct. Further, Eq. (12) takes into ac-

count the effect of f_{pv} / f_{pu} , and thus brings out the advantage of using low-relaxation steel.

Loov's method appears to have a mathematical form that would give a better fit than the predominantly straight-line relationships of the ACI Code method (see Figs. 8-11 and 14-16), and Harajli and Naaman's method (see Fig. 8-11, and 14). It is limited in scope, however, to the same applications as the other two methods.

CONCLUSION

The flexural strength theory of bonded prestressed and partially prestressed concrete members is reviewed and analysis by the strain compatibility method is described. A computer program for flexural analysis by the strain compatibility method is provided in BASIC for IBM PC/XT and AT microcomputers and compatibles. Program users can take advantage of higher tendon capacities with adequate documentation of actual stress-strain curves. The program and its manual are available from the PCI for a nominal charge.

A new approximate method for calculating the stress in prestressed and nonprestressed tendons at ultimate flexure is also presented. It is applicable to sections of any shape, composite or non-composite, with any number of steel layers, and with any type of ASTM tendons stressed to any level. Parametric and comparative studies indicate that the proposed method is more accurate and more powerful than Eq. (18-3) of ACI 318-83 and other available approximate methods.

The proposed method is illustrated by two numerical examples and results are compared with those of the iterative strain compatibility method and with other approximate methods. Proposed ACI 318-83 Code and Commentary revisions are given in Appendix B.

Table 6. Summary of approximate methods for determining f_{ps} .

(1) PROPOSED	(2) ACI 318-83 ⁵	(3) HARAJLI & NAAMAN ⁷	(4) LOOV ¹⁶
<p>Steps:</p> <p>(1) Assume tensile steel stresses = respective yield points and compressive steel stress = 0, and use force equilibrium to compute F_c.</p> <p>(2) Set $F = \sum 0.85 f'_c A_c$ for all concrete types in compression, and compute a.</p> <p>(3) $c = a / \beta_1$. For composite sections assume $\frac{\sum 0.85 (f'_c A_c \beta_1)_k}{k}$ $\beta_1 \text{ ave.} = \frac{F_c}{F}$</p> <p>(4) Compute steel strains in each layer "i". $\epsilon_i = \epsilon_{cu} \left(\frac{d_i}{c} - 1 \right) + \epsilon_{i, \text{dec}}$ where $\epsilon_{i, \text{dec}} = f_{se} / E_i$ or $\epsilon_{i, \text{dec}} = (f_{pi} - 25,000) / E_i$ whichever is applicable.</p> <p>(5) Use power formula to compute steel stresses. $f_i = \epsilon_i E_i \left[Q + \frac{1-Q}{(1 + \epsilon_i^* R)^{1/R}} \right] \leq f_{pu}$ where $\epsilon_i^* = \frac{\epsilon_i E_i}{K f_{py}}$</p>	$f_{ps} = f_{pu} \left[1 - \frac{\gamma_p}{\beta_1} \left[\rho_p \frac{f_{pu}}{f'_c} + \frac{d}{d_p} (\omega - \omega') \right] \right]$ <p>Conditions: If compression reinforcement is taken into account: $\left[\rho_p \frac{f_{pu}}{f'_c} + \frac{d}{d_p} (\omega - \omega') \right] \geq 0.17,$ and $d' \leq 0.15 d_p$ where $\gamma_p = 0.55$ for $f_{py} / f_{pu} \geq 0.80$ $= 0.40$ for $f_{py} / f_{pu} \geq 0.85$ $= 0.28$ for $f_{py} / f_{pu} \geq 0.90$ d_p = depth to prestressed tendons d = depth to nonprestressed tension bars d' = depth to compression bars $\rho_p = A_{ps} / bd_p$ $\omega = (A_s / bd) (f_y / f'_c)$ $\omega' = (A'_s / bd) (f_y / f'_c)$ b = width of compression face A_p, A_s, A'_s = steel areas at depths $d_p, d,$ & d'.</p>	$f_{ps} = f_{pu} \left[1 - 0.3 \frac{c_e}{d_u} \right]$ <p>or, $f_{ps} = f_{pu} \left[1 - 0.3 \frac{c_u}{d_u} \right]^*$</p> <p>where $d_e = \frac{A_p f_{ps} d_p + A_s f_y d_s}{A_p f_{ps} + A_s f_y}$ $d_u = \frac{A_p f_{pu} d_p + A_s f_y d_s}{A_p f_{pu} + A_s f_y}$ $c_u = \frac{A_p f_{pu} + A_s f_y - A'_s f_y}{0.85 \beta_1 f'_c b + 0.3 \frac{A_p f_{pu}}{d_u}}$ for $\beta_1 c \leq h_f$ $c_u = \frac{A_p f_{pu} + A_s f_y - A'_s f_y - T_f}{0.85 \beta_1 f'_c b_w + 0.3 \frac{A_p f_{pu}}{d_u}}$ for $\beta_1 c \geq h_f$ $T_f = 0.85 f'_c (b - b_w) h_f$ A_p = area of prestressed steel d_s = depth to nonprestressed tension bars. Other symbols are as per the ACI Code.</p>	$f_{ps} = f_{pu} \left[\frac{1 - k_h \frac{c_{st}}{d_{ps}}}{1 + k_h \frac{c_{pu}}{d_{ps}}} \right]$ <p>where $k_h = 2 \left(1.04 - \frac{f_{py}}{f_{pu}} \right)$ $c_{st} = \frac{A_s f_y - A'_s f_y - 0.85 f'_c (b - b_w) h_f}{0.85 \beta_1 f'_c b_w d_p}$ $c_{pu} = \frac{A_{ps} f_{pu}}{0.85 \beta_1 f'_c b_w d_p}$</p> <p>Conditions: 1) $c > h_f / \beta_1$, otherwise treat as a rectangular section. 2) $c > d' / (1 - \epsilon'_y / \epsilon_c)$, Otherwise ignore compression steel in the c_{st} formula. where ϵ'_y = yield strain of compression steel ϵ_c = ultimate concrete strain.</p>

* To obtain c_e , change f_{pu} to f_{ps} and d_u to d_e .

Table 7. Comparison of the features of the approximate methods for determining f_{ps} .

FEATURE	METHOD			
	(1) PROPOSED	(2) ACI 318-83 ⁵	(3) HARAJLI & NAAMAN ⁷	(4) LOOV ¹⁶
SIMPLICITY	Slightly lengthier than Method (2) for the same applications	Simplest where applicable	Same as (1)	Same as (1)
ACCURACY*	Very accurate	Reasonable where applicable	Slightly less accurate than method (2)	Expected to be slightly more accurate than method (2)
CROSS SECTION SHAPE	Any shape	Developed for rectangular sections. May be inaccurate for other shapes.	Rectangular and T sections. Must be modified for other shapes.	Same as (3)
COMPOSITE SECTIONS	Yes	No	No. Must be modified for more than one concrete type.	Same as (3)
NONPRESTRESSED STEEL	Any type	Mild bars only	Same as (2)	Same as (2)
NUMBER OF TENDON STEEL TYPES	All ASTM steels. Power formula constants can be easily determined for future types.	Steels with f_{py}/f_{pu} = 0.80, 0.85, & 0.90	No distinction between steel types	Valid for all f_{py}/f_{pu} values
NUMBER OF STEEL LAYERS	No limit	Maximum = 3	Same as (2)	Same as (2)
COMPRESSION STEEL YIELDING	Automatically checked	Conditions for yielding are given	Not part of original proposal, but conditions were developed ¹⁷ later to match Method (2)	Condition placed on (c/d') to guarantee yielding.
CONDITION ON EFFECTIVE PRESTRESS	No conditions	$f_{se} \geq 0.5 f_{pu}$	$f_{se} \geq 0.5 f_{pu}$	$f_{se} \geq 0.60 f_{py}$

* Relative to the strain compatibility method with conditions of Section 10.2 of ACI 318-83, and minimum ASTM standard steel properties.

REFERENCES

1. Mattock, A. H., "Flexural Strength of Prestressed Concrete Sections by Programmable Calculator," *PCI JOURNAL*, V. 24, No. 1, January-February 1979, pp. 32-54.
2. Menegotto, M., and Pinto, P. E., "Method of Analysis for Cyclically Loaded R. C. Plane Frames, Including Changes in Geometry and Non-Elastic Behavior of Elements Under Combined Normal Force and Bending," International Association for Bridge and Structural Engineering, Preliminary Report for Symposium on Resistance and Ultimate Deformability of Structures Acted on by Well-Defined Repeated Loads, Lisbon, Portugal, 1973, pp. 15-22.
3. Naaman, A. E., "Ultimate Analysis of Prestressed and Partially Prestressed Sections by Strain Compatibility," *PCI JOURNAL*, V. 22, No. 1, January-February 1977, pp. 32-51.
4. Naaman, A. E., "An Approximate Non-linear Design Procedure for Partially Prestressed Beams," *Computers and Structures*, V. 17, No. 2, 1983, pp. 287-293.
5. ACI Committee 318, "Building Code Requirements for Reinforced Concrete (ACI 318-83)," American Concrete Institute, Detroit, Michigan, 1983.
6. Mattock, A. H., "Modification of ACI Code Equation for Stress in Bonded Prestressed Reinforcement at Flexural Ultimate," *ACI Journal*, V. 81, No. 4, July-August 1984, pp. 331-339.
7. Harajli, M. H., and Naaman, A. E., "Evaluation of the Ultimate Steel Stress in Partially Prestressed Flexural Members," *PCI JOURNAL*, V. 30, No. 5, September-October 1985, pp. 54-81. See also discussion by A. H. Mattock and Authors, V. 31, No. 4, July-August 1986, pp. 126-129.
8. ACI Committee 318, "Commentary on Building Code Requirements for Reinforced Concrete (ACI 318-83)," (ACI 318R-83), American Concrete Institute, Detroit, Michigan, 1983, 155 pp. See also the 1986 Supplement.
9. Mattock, A. H., and Kriz, L. B., "Ultimate Strength of Structural Concrete Members with Nonrectangular Compression Zones," *ACI Journal*, Proceedings V. 57, No. 7, January 1961, pp. 737-766.
10. Mattock, A. H., Kriz, L. B., and Hognestad, E., "Rectangular Concrete Stress Distribution in Ultimate Strength Design," *ACI Journal*, Proceedings V. 57, No. 8, February 1961, pp. 875-928.
11. Tadros, M. K., "Expedient Service Load Analysis of Cracked Prestressed Concrete Sections," *PCI JOURNAL*, V. 27, No. 6, November-December 1982, pp. 86-111. See also discussion by Bachmann, Bennett, Branson, Brøndum-Nielsen, Bruggeling, Moustafa, Nilson, Prasada Rao and Natarajan, Ramaswamy, Shaikh, and Author, V. 28, No. 6, November-December 1983, pp. 137-158.
12. Naaman, A. E., "Partially Prestressed Concrete: Review and Recommendations," *PCI JOURNAL*, V. 30, No. 6, November-December 1985, pp. 30-71.
13. *Notes on ACI 318-83 Building Code Requirements for Reinforced Concrete with Design Applications*, Fourth Edition, Portland Cement Association, Skokie, Illinois, 1984, pp. 25-31 to 25-34.
14. Skogman, B. C., "Flexural Analysis of Prestressed Concrete Members," M. S. Thesis, Department of Civil Engineering, University of Nebraska, Omaha, Nebraska, 1988.
15. *PCI Design Handbook*, Third Edition, Prestressed Concrete Institute, Chicago, Illinois, 1985, p. 11-18.
16. Loov, R. E., "A General Equation for the Steel Stress, f_{ps} , for Bonded Members," to be published in the November-December 1988 *PCI JOURNAL*.
17. Proposal to ACI-ASCE Committee 423, Prestressed Concrete, on changes in the Code provisions for prestressed and partially prestressed concrete. Submitted by A. E. Naaman, on March 8, 1987.

* * *

APPENDIX A — NOTATION

The symbols listed below supplement and supersede those given in Chapter 18 of ACI 318-83.

Sign convention: Tensile stress in steel and compressive stress in concrete are positive.

a	= depth of equivalent rectangular stress block as defined in Section 10.2.7 of ACI 318-83	f_{ns}, f_{ps}	= stress in nonprestressed and prestressed reinforcement at ultimate flexure
A_c	= area in compression for a type of concrete. There is only one concrete type in noncomposite construction.	$f_{ns,e}, f_{se}$	= stress in nonprestressed and prestressed reinforcement after allowance for time-dependent effects
A_{ns}, A_{ps}	= areas of nonprestressed and prestressed tension reinforcement	f_{pi}	= initial tendon stress before losses
b	= width of compression face of member	f_{pu}	= specified tensile strength of prestressing tendons
c	= distance from extreme compression fiber to neutral axis	f_{py}	= specified yield strength of prestressing tendons
C	= total compressive force in cross section of member	f'_s	= stress in compressive reinforcement at ultimate flexure
d_i	= distance from extreme compression fiber to centroid of steel layer "i"	f_y	= specified yield strength of nonprestressed mild reinforcement
d_{ns}, d_{ps}	= distances from extreme compression fiber to centroids of nonprestressed and prestressed tension reinforcement	h	= overall thickness of member
d_{top}	= overall depth of concrete topping	h_f	= thickness of flange of flanged sections
d'	= distance from extreme compression fiber to centroid of compression steel	i	= a subscript identifying the steel layer number. A steel layer "i" is defined as a group of bars or tendons with the same stress-strain properties (type), the same effective prestress, and that can be assumed to have a combined area with a single centroid.
E	= modulus of elasticity; subscript "i" refers to reinforcement layer number.	K, Q, R	= constants used in Eq. (6)
E_{ns}, E_{ps}	= moduli of elasticity of nonprestressed and prestressed reinforcement	T	= total tensile force in cross section
f'_c	= specified compressive strength of concrete; second subscripts "pc" and "top" refer to precast (first stage) and topping (second stage) concretes, respectively.	β_1	= a/c factor defined in Section 10.2.7 of ACI 318-83 = $[0.85 - 0.05 (f'_c - 4 \text{ ksi})] \leq 0.85$ and ≥ 0.65
F_c	= total compressive force in concrete at ultimate flexure	ϵ_{cu}	= maximum usable compressive strain at extreme concrete fiber, normally taken equal to 0.003
f_i	= stress in tendon steel corresponding to a strain ϵ_i	ϵ_i	= strain in steel layer "i" at ultimate flexure
		$\epsilon_{i,dec}$	= strain in steel layer "i" at concrete decompression

$\epsilon_{ns,dec}$, $\epsilon_{ps,dec}$ = strain in nonprestressed and prestressed tension reinforcement at concrete decompression

ϵ_{ps} = strain in prestressed tendon reinforcement at ultimate flexure

ϵ_{pu} = strain in high strength tendon at stress f_{pu}

ϵ_{py} = yield strain of prestressing tendon

ϵ'_s = strain in compression steel at ultimate flexure

$\epsilon'_{s,dec}$ = strain in compression steel at concrete decompression

* * *

ACKNOWLEDGMENT

The authors wish to thank Ronald G. Dull, chairperson of the PCI Committee on Prestressing Steel, the Union Wire Rope Division of Armco Inc., Florida Wire and Cable Co., Prestress Supply Inc., Shinko Wire America Inc., Siderius Inc., Springfield Industries

Corp., and Sumiden Wire Products Corp. for supplying the stress-strain curves used in the preparation of this paper. The authors also wish to express their appreciation to the reviewers of this article for their many helpful suggestions.

* * *

COMPUTER PROGRAM

A package (comprising a printout of the computer program, user's manual, and diskette suitable for IBM PC/XT and AT microcomputers) is available from PCI Headquarters for \$20.00.

APPENDIX B — PROPOSED ACI 318-83 CODE AND COMMENTARY REVISIONS

If the proposed revisions are incorporated into the Code⁵ and Commentary,⁸ the reference, equation, and table numbers given herein will need to be changed.

Proposed Code Revisions

It is proposed that the following notation be changed in Section 18.0 of the Code: Replace A_s with A_{ns} , d with d_{ns} , and d_p with d_{ps} . Delete γ_p .

It is proposed that Sections 18.7.1, 18.7.2, and 18.7.3 of the Code be revised to read as follows:

18.7.1 — Design moment strength of flexural members shall be computed by the strength design methods of this Code. The stress in steel at ultimate flexure is f_{ps} for prestressed tendons and f_{ns} for nonprestressed tendons.

18.7.2 — In lieu of a more accurate determination of f_{ps} and f_{ns} based on strain compatibility, the following approximate values of f_{ps} and f_{ns} shall be used.

- (a) For members with bonded prestressing tendons, f_{ps} and f_{ns} may be closely approximated by the method given in the Commentary to this Code.
- (b) The formulas in Sections 18.7.2 (c) and 18.7.2 (d) shall be used only if f_{se} is not less than $0.5 f_{pu}$.
- (c) Use Section 18.7.2 (b) of ACI 318-83.
- (d) Use Section 18.7.2 (c) of ACI 318-83.

18.7.3 — Nonprestressed mild reinforcement conforming to Section 3.5.3, if used with prestressing tendons, may be considered to contribute to the tensile force and may be included in moment strength computations at a stress equal to the specified yield strength f_y .

Proposed Commentary Revisions

It is proposed that the following nota-

tion be added to Appendix C of the Commentary:

- A_c = area in compression for a type of concrete. There is only one concrete type in noncomposite construction.
- d_i = distance from extreme compression fiber to centroid of steel layer "i"
- E = modulus of elasticity of reinforcement (Chapter 18)
- F_c = total compressive force in concrete at ultimate flexure
- f_i = stress in steel layer "i" corresponding to a strain ϵ_i
- f_{pi} = initial tendon stress before losses
- i = a subscript identifying the steel layer number. A steel layer "i" is defined as a group of bars or tendons with the same stress-strain properties (type), the same effective prestress, and that can be assumed to have a combined area with a single centroid.
- K, Q, R = constants defined in Table B-1* for the ASTM properties of the steel of layer "i"
- ϵ_i = strain in steel layer "i" at ultimate flexure
- $\epsilon_{i,dec}$ = strain in steel layer "i" at concrete decompression
- ϵ_y = yield strain of mild reinforcement

It is proposed that the first paragraph of Section 18.7.1 and the first four paragraphs of Section 18.7.2 of the Commentary be revised to read as follows:

18.7.1 — Design moment strength of prestressed flexural members may be computed using the same strength equations as those for conventionally reinforced concrete members. Equations given in Sections 18.7.1.A and

* Same as Table 1 of this paper.

18.7.1.B of the Commentary are valid except when nonprestressed tendon reinforcement is used in place of mild tension reinforcement. In this case the stress in the nonprestressed tendon reinforcement, f_{ns} , should be used instead of f_y .

18.7.2 — A microcomputer program for determining flexural strength by the strain compatibility method, using the assumptions given in Section 10.2, is available from Refs. A and B.* In lieu of the iterative computer analysis, the following approximate procedure may be used for determining the stress, f_i , in any steel layer "i". A layer "i" is defined as a group of bars or tendons with the same stress-strain properties (type), the same effective prestress, and that can be assumed to have a combined area with a single centroid. The procedure given below is valid regardless of the section shape, number of concrete types in the section, number of steel layers, and level of effective prestress, f_{se} .

A. General Case — Noncomposite or Composite Cross Sections of General Shape with any Number of Steel Layers

Step 1: Initially assume the tensile steel stresses equal to the respective yield points of the steel types used and the compressive steel stress equal to zero, and use force equilibrium ($T = C$) to compute the total compressive force in concrete, F_c .

Step 2: Using the provisions of Section 10.2.7, compute the depth of the stress block, a . For composite sections, the force F_c may have more than one component, $0.85 f'_c A_c$, where f'_c and A_c are the strength and area in compression of each concrete part in the section.

Step 3: Compute the neutral axis depth

$c = a/\beta_1$. For composite sections, assume an average β_1 as follows:

$$\beta_1 \text{ ave.} = \frac{\sum_k 0.85 (f'_c A_c \beta_1)_k}{F_c} \quad (\text{B-1})$$

where k is the concrete type number.

Step 4: Compute the strain in each steel layer "i" by:

$$\epsilon_i = 0.003 \left(\frac{d_i}{c} - 1 \right) + \epsilon_{i,dec} \quad (\text{B-2})$$

where $\epsilon_{i,dec}$ may be approximated as f_{se}/E_i . If a layer consists of partially tensioned tendons, $\epsilon_{i,dec}$ may be taken = $(f_{pi} - 25,000 \text{ psi})/E_i$ where f_{pi} = initial prestress, psi. For nonprestressed tendons or mild bars, $\epsilon_{i,dec}$ may be taken = $-25,000 \text{ psi}/E_i$.

Step 5: Compute the stress in each tendon steel layer "i" by:

$$f_i = \epsilon_i E \left[Q + \frac{1 - Q}{(1 + \epsilon_i^{*R})^{1/R}} \right] \leq f_{pu} \quad (\text{B-3})$$

where

$$\epsilon_i^* = \frac{\epsilon_i E}{K f_{pu}} \quad (\text{B-4})$$

The constants E , K , Q , and R depend on the stress-strain properties of the tendon steel type used. For steels satisfying minimum ASTM standards, values for these constants may be taken from Table B-1.† The stress in mild reinforcement layers may be found using Section 10.2.4.

Step 6: If additional accuracy is desired, an improved value of a may be obtained by repeating Steps 1 and 2 with the steel stresses from Step 5. Take moments about any level in the section to compute the flexural strength, M_n .

B. Special Case — Noncomposite Sections with Uniform Compression Block Width and up to Three Steel Layers: prestressed tension

* Refs. A and B correspond to this paper and Ref. 14, respectively.

† Same as Table 1 of this paper.

tendons, nonprestressed tension mild bars, and nonprestressed compression mild bars

This special case is the only one addressed in the 1983 Edition of the Code. For this case, the first four steps of Procedure A reduce to the following formula:

$$\epsilon_i = 0.003 \left(\frac{0.85 f'_c b \beta_1 d_i}{A_{ps} f_{pu} + A_{ns} f_y} - 1 \right) + \epsilon_{i,dec} \quad (B-5)$$

where "i" refers to *ps*, *ns*, or *s'*. The steel stress in each layer "i" may then be calculated by Eqs. (B-3) and (B-4). Normally, mild tension bars yield at ultimate flexure, i.e., $\epsilon_i \geq \epsilon_y$. It is important, however, to apply Eq. (B-5) to the compression steel layer to verify yielding.

C. Improvements over the 1983 Code

The procedures described in Sections A and B provide the following advantages over Eq. (18-3) of the 1983 Code.

1. Steel stresses are more accurately determined.

2. The proposed method is valid for all levels of effective prestress. Thus, it is applicable to sections where both prestressed and nonprestressed tendons are included.

3. The method is not limited to sections where the equivalent rectangular stress block is of uniform width. Thus, it is applicable to all cross-sectional shapes.

4. Composite sections with more than one f'_c can be analyzed."

* * *

NOTE: Discussion of this paper is invited. Please submit your comments to PCI Headquarters by June 1, 1989.